



COVIND
unlimited quality



SPECCHI RETROVISORI E COMPONENTI
REAR MIRRORS AND COMPONENTS

2020

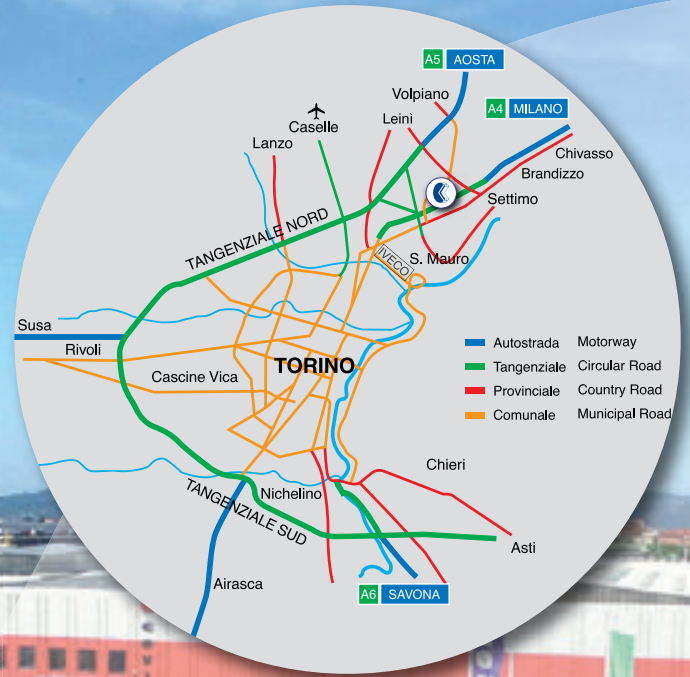



Specchi retrovisori e componenti
Rear mirrors and components
Rückspiegel und Zubehör

11.2020





COVIND



كافة التفاصيل المذكوره هنا، وبالرغم من قابليتها للتبديل مع التفاصيل الاصلية بشكل متطابق تماما، إلا انها ليست الاصلية، نفس التفاصيل يتم الاستعانه بها واستخدامها فقط للعربات السائره و فقط بعد الحصول على التصريح بالموافقه من مالك العربيه التي يتم إصلاحها.
الأرقام الارشاديه الاصلية يتم وضعها بغرض الاستعلام، نرجو أن يتم دائما ذكر أرقامنا الخاصة الارشاديه في التعاقدات وطلبات الشراء.
هذا الكاتالوج بلغي كافة الكاتالوجات السابقه ويحل محلها.



Всички особености изредени по-долу, независимо от това, че са взаимозаменяеми с оригиналите, **не са оригинали**. Те биват използвани само за превозните средства в движение и само след упълномощаване от страна на собственика на превозното средство в ремонт.



Selv om de sagtens kan bruges i stedet for de originale er de reservedele der indgår i **denne liste ikke originale**. Disse reservedele bruges kun til aktive køretøjer og udelukkende med ejerens tilladelse, mens reparationen udføres. De originale referencekoder fremstår kun som en oplysning. De bedes angive vores referencekoder i f.m. forhandlinger og bestillingssedler. Det nye katalog annullerer og erstatter alle tidligere udgaver.



Selles nimekirjas olevad varuosad ei ole originaalid vaatamata sellele, **et on originaalidega võrdväärset kasutatavad**. Neid osasid kasutada ainult töös olevatel sõidukitel ja üksnes remonditava sõiduki omaniku loal. Originaali viitenumbrid on ära toodud ainult infoks. Palume müügi- ja tellimislehtedel ära märkida meie viitenumbrid.
Käesoleva kataloogi nimekiri tühistab ja asendab varasemad.



Tässä luetteloidut varaosat eivät ole alkuperäisosa, vaikka **ne ovatkin laadultaan alkuperäisosa vastaavia**. Osat on tarkoitettu käytettäväksi liikenteessä olevissa autoissa ja niitä käytetään vain korjattavan ajoneuvon omistajan luvalla. Alkuperäiset tuotekoodit mainitaan vain tiedon vuoksi. Pyydämme teitä käyttämään neuvotteluissa ja tilauslomakkeissa meidän tuotekoodejamme. Uusi tuoteluettelo peruuttaa ja korvaa aikaisemmat luettelot.



Toutes les pièces détaillées ci-dessus, tout en étant parfaitement interchangeables avec les pièces d'origine, **ne sont pas originales**. Les mêmes pièces sont utilisées exclusivement sur les véhicules en circulation et seulement sous autorisation du propriétaire du véhicule en réparation. Les codes de référence originales sont indiqués à titre purement documentaire. Dans les négociations et les commandes veuillez bien citer nos codes de référence. Le présent catalogue annule et remplace tous les précédents.



Alle hier aufgeführten Bestandteile sind exakt austauschbar mit den Originalteilen, **aber es sind keine Originale**. Diese Teile werden nur angewendet und eingesetzt für die Fahrzeuge die im Umlauf sind und nur nach Einverständnis mit dem Eigentümer, dessen Fahrzeug in der Reparatur ist. Die Original-Referenznummern wurden rein informativ nochmals wiedergegeben. Bei Anfragen und bei Bestellungen bitten wir Sie immer die Referenznummern anzugeben. Der beigelegte Katalog ersetzt und annulliert die vorhergehenden Kataloge.



Κάθε ανταλλακτικό που απαριθμείται εδώ, ακόμα κι αν όντας τέλεια ανταλλάξιμο με το γνήσιο, **δεν είναι γνήσιο**. Αυτά τα μέρη χρησιμοποιούνται μόνο στα οχήματα που είναι σε κυκλοφορία και αποκλειστικά μετά από την έγκριση του ιδιοκτήτη του οχήματος για επισκευή. Οι γνήσιοι κωδικοί που αναφέρονται υπάρχουν για πληροφοριακούς λόγους μόνο. Παρακαλούμε όπως χρησιμοποιείτε για οποιαδήποτε συναλλαγή/ παραγγελία σας τους δικούς μας αναφερόμενους κωδικούς. Ο παρών κατάλογος ακυρώνει και αντικαθιστά προηγούμενους.



Spare parts listed here, even though perfectly interchangeable with the original ones, **are not original**. These parts are used only on vehicles in circulation and exclusively under authorization of the owner of the vehicle in repair. The original reference codes are indicated for information only. You are kindly requested to indicate our reference codes in negotiations and order sheets. The present catalogue list cancels and replaces previous ones.



قطعات قید شده در اینجا، با اینکه کاملاً قابل تعویض با قطعات اصلی می باشند، قطعات اصلی نیستند. این قطعات تنها برای خودروهایی که در جریان می باشند (خارج از محل تولید می باشند) مورد استفاده قرار می گیرند و منحصرأ تحت اختیار و نضر مالک خودروی در حال تعمیر می باشند. با احترامات ما از شما شماره کد ارجاع اصلی تنها برای اطلاعات می باشند. تقاضا داریم که شماره کد ارجاع را در زمان مذاکره و در ورقه تقاضا مشخص کنید. لیست



Tutti i particolari qui elencati, pur essendo perfettamente intercambiabili con gli originali, **non sono originali**. Gli stessi vengono impiegati ed utilizzati solo per i veicoli in circolazione e solo dopo autorizzazione da parte del proprietario del veicolo in riparazione. I numeri di riferimento originali sono riportati a puro titolo informativo. Nelle trattative e nelle ordinazioni si prega di voler sempre citare i nostri numeri di riferimento. Il presente catalogo annulla e sostituisce tutti i precedenti.



Kaut arī uzskaitītās rezerves daļas var pilnīgi aizstāt oriģinālās, **tās nav oriģinālas**. Šīs rezerves daļas tiek izmantotas vienīgi apgrozībā esošiem transporta līdzekļiem un tikai ar remontējamā transporta līdzekļa īpašnieka atļauju. Oriģinālais atsauces numurs tiek uzrādīts vienīgi informācijai. Lūdzam norādīt jūsu atsauces numurus sarunu laikā un uz pasūtījuma lapas. Šis kataloga saraksts anulē un aizstāj visus iepriekšējos.



Čia išvardytos atsarginės dalys nėra originalios, tačiau jomis galima pakeisti originaliąsias. Šios dalys naudojamos tik apyvartoje esančiuose automobiliuose ir tik gavus remontuojamo automobilio savininko sutikimą.

Originalių dalių kodai nurodomi tik informacijos sumetimais. Maloniai prašome nusiskundimuose ir užsakymų lapuose nurodyti dalių kodus.

Šiame kataloge pateikiamas sąrašas anuliuoja ir pakeičia ankstesniusius.



Reservedelene som er oppført her, er ikke **originale reservedeler**, selv om de fullt ut kan benyttes ved utskiftning av de opprinnelige delene. De skal kun benyttes på kjøretøy som er i bruk og med eierens samtykke. De opprinnelige referansekodene angis kun til etterretning. Vennligst angi våre referansekoder under forhandling og ved bestilling. Denne katalogen annullerer og erstatter alle tidligere kataloger.



Hoewel elk reserveonderdeel dat hier vermeld wordt perfekt kan worden gebruikt in de plaats van de originele stukken, **gaat het hier dus niet om originele onderdelen**. Deze onderdelen worden enkel gebruikt voor voertuigen in circulatie en enkel met de toestemming van de eigenaar van het voertuig dat in reparatie is. De originele referentiecodes worden enkel ter informatie weergegeven. U wordt vriendelijk verzocht om onze referentiecodes te gebruiken in gesprekken en op de bestelformulieren. De huidige catalogoog annuleert en vervangt de vorige versies.



Wszystkie detale tu podane ,choć będąc doskonałe wymienne z oryginałami, **nie są oryginalne**.

Te same zostają zastosowane i użyte tylko dla pojazdów w obiegu i tylko po autoryzacji ze strony właściciela pojazdu będącego w naprawie.

Oryginalne numery referencyjne są umieszczone w celu czysto informacyjnym.

W czasie rozmów handlowych i zamówień, prosi się zechcieć zawsze cytować nasze numery referencyjne.

Niniejszy katalog anuluje i zastępuje wszystkie poprzednie.



Todas as peças aqui listadas, ainda que sejam perfeitamente intercambiáveis com as originais, **não são originais**. Estas peças só são empregues e utilizadas nos veículos em circulação e só após autorização prévia por parte do proprietário do veículo a reparar. Os números de referência originais têm um carácter puramente informativo. Nos contactos e encomendas, indique sempre os números de referência, por favor.



Veškeré zde uvedené součástky **nejsou originální díly**, i když jsou za ně stoprocentně zaměnitelné. Tyto součástky je možné použít pouze pro vozidla v provozu a pouze se souhlasem majitele vozidla, které má být opraveno. Referenční čísla originálních dílů jsou uvedena pouze informativně. Při jednáních a na objednávkách je nutné vždy uvést naše referenční čísla.

Tento katalog anuluje a nahrazuje veškeré předchozí katalogy.



Toate produsele enumerate in continuare, chiar daca sunt perfect interschimbabile cu cele originale, **nu sunt originale**. Ele sunt utilizate, numai pentru autovehiculele in circulatie si exclusiv cu acordul proprietarului autovehiculului de reparat. Codurile originale sunt indicate numai in scop informativ. Cu ocazia tratativelor verbale, cat si a emiterii ordinelor scrise, clientii sunt rugati sa utilizeze codurile noastre (COVIND) ca referinta. Prezentul catalog anuleaza si le inlocuieste pe cele precedente.



Все перечисленные запчасти не являются оригинальными, **хотя могут отлично их заменить**. Эти запчасти используются при ремонте автомобилей только с согласия владельца.

Ссылки на порядковый номер оригинальных запчастей указаны исключительно в ориентировочных целях.

При покупках и заказах рекомендуем указывать НАШИ номера запчастей.

Настоящий каталог аннулирует и заменяет все предыдущие.

Оригинальные ориентировочные номера са изнесени само за ваша информация. При преговори и при поръчки молим винаги да цитирате нашите ориентировочни номера.

Настоящият каталог анулира и замества всички съществуващи до момента.



Ovdje popisani prièuvni dijelovi, èak i kada savršeno zamjenjuju izvorne, **nisu izvorni**. Ti dijelovi mogu se uporabiti jedino na vozilima u cirkulaciji i na temelju izrièitoga odobrenja vlasnika vozila na popravku.

Brojevi dijela izvornih dijelova navedeni su samo kao primjer. Najljepše vas molimo da u vašim zahtjevima i narudžbama navedete brojeve dijela.

Sadašnji katalog ukida valjanost svih prethodnih kataloga.



Èeprav jih je možno perfektno izmenjati z originalnimi deli, tukaj navedeni nadomestni deli niso originalni. Te dele se uporabljajo samo v vozilih v prometu in izkljuèno samo pod pogojem, da lastnika vozila v popravilu izda zato dovoljenje. Navedene originalne referenène kode so le informativne. Prosimo vas, da navedite naše referenène kode pri pogajanju in na naroèilih. S sedanjim seznamom prenehajo veljati prejšnji sezname in jih nadomesti.



Todos los elementos detallados a continuación, aunque totalmente intercambiables con los originales, **no son originales**. Estos mismos se emplean y utilizan unicamente para vehículos en circulación y previa autorización del propietario del vehículo en reparación. Los numeros de referencia originales se citan a título informativo. En las negociaciones y en los pedidos se ruega citar siempre nuestros numeros de referencia. El presente catálogo anula y substituye todos los anteriores.



Reservdelarna i denna lista är inte originaldelar trots att de **är fullkomligt utbytbara med de ursprungliga**. Dessa delar används endast på fordon i cirkulation och enbart efter godkännande av ägaren till det fordon som lämnats på reparation. De originala referenskoderna anges endast för information. Var god ange våra referenscodes i negocieringar och beställningsblanketter. Den nuvarande kataloglistan annullerar och ersätter de föregående.



Devamında detaylandırılan tüm elementler, orijinaleri ile tamamen değiştirilebilir olmasına rağmen, **orijinal değildirler**. Bunlar, yalnızca dolaşımda bulunan araçlarda ve tamirde bulunan aracın sahibinden ön onay alınması kaydıyla uygulanabilir ve kullanılabilir.

Orijinallerin referans numaraları bilgi başlığında yer almaktadır.

Görüşmelerde ve siparişlerde referans numaralarımızın her zaman belirtilmesi rica olunur.

Bu katalog tüm önceki versiyonları geçersiz kılar ve bunların yerine geçer.



Перелічені тут запасні частини не є оригінальними, але цілком взаємозамінні з оригінальними. Ці запасні частини застосовуються тільки на транспортних засобах, що знаходяться в експлуатації і винятково з дозволу власника, що здав транспортний засіб у ремонт.

Коди оригінальних запасних частин наводяться тільки для довідки. Прохання вказувати довідкові коди запасних частин при веденні переговорів і на бланках замовлення.

Даний каталог скасовує дію раніше виданих каталогів і замінює ці каталоги.



Az itt felsorolt tartalék alkatrészek, még akkor is, ha megfelelően felcserélhetők az eredetiekkel, nem az eredetiek. Ezeket az alkatrészeket csak forgalomban lévő járművek javításánál használják és kizárólag a jármű tulajdonosának engedélyével.

Az eredeti referencia kódokat csak információs célból jelzik. Kérjük legyen szíves jelezze a referencia kódjainkat a tárgyalásokon és a megrendelési dokumentumban.

A jelenlegi katalógus lista vissza van vonva és újra az előző lista van érvényben.

Si consiglia di consultare sempre il catalogo on-line per gli ultimi aggiornamenti.

Please visit the catalogue on-line for the latest updates.

il est conseillé de toujours consulter le catalogue en ligne pour les dernières mises à jour.

Wir empfehlen Ihnen immer unsere on line Kataloge nachzuschlagen, um die letzten Aktualisierungen zu kennen

Les recomendamos consulten siempre el catálogo en línea para las últimas actualizaciones.

<http://catalogo.covind.it>



Recomenda-se a consulta do catálogo eletrónico para informação das novas atualizações.

Zaleca się odwiedzać zawsze katalog on-line zawierający najnowsze aktualizacje

E consiliabila intotdeauna, consultarea catalogului on-line pentru cunoasterea ultimilor actualizari.

Пожалуйста, обратите внимание на последние обновления каталогов on-line

للأطلاع على آخر التحسينات،
الرجاء الرجور دائما الى كاتالوجاتنا على الخط.

www.covind.it



La qualità COVIND per una visibilità ottimale

La COVIND, leader nella produzione e distribuzione di componenti per veicoli commerciali ed industriali, a seguito della recente acquisizione di nuove realtà produttive ed industriali, ha deciso di inserire, nell'ambito della gamma di prodotto, gli "specchi retrovisori". Si tratta di una nuova e specifica linea, introdotta a completamento dell'ampio range aziendale, con un'offerta dedicata ai vari modelli di veicoli, prodotti da costruttori Europei (DAF, IVECO, MAN, MERCEDES-BENZ, RENAULT, SCANIA e VOLVO). La capacità innovativa, il know-how progettuale, l'utilizzo di tecnologie produttive all'avanguardia, il rispetto degli elevati standard qualitativi, da sempre caratterizzanti il mondo COVIND, consentono di poter offrire un prodotto perfettamente in linea con le aspettative dei professionisti della riparazione e con le esigenze dei driver più esigenti. Gli specchi retrovisori esterni COVIND sono certificati ed omologati, risultando un prodotto assolutamente equivalente all'originale e perfettamente intercambiabile con lo stesso. I materiali utilizzati, la componentistica impiegata, la precisione caratterizzante gli assemblaggi, l'attenzione dedicata alla lavorazione del vetro (argentatura, protezione superficie riflettente, pulitura e lucidatura finale), costituiscono una garanzia in termini di funzionalità e durata nel tempo.

Covind quality for better visibility

Following to the recent acquisition of new industrial companies, Covind, leader in body parts and components for trucks and commercial vehicles, decided to include, as part of its products line, the rear mirrors. It is a new and specific line, thought and introduced as complement of the wide range and servicing the models manufactured by the European vehicles constructors (DAF, IVECO, MAN, MERCEDES-BENZ, RENAULT, SCANIA and VOLVO). Main Covind must like the inclination to innovation, the design know-how, the cutting edge technologies, in addition to the excellent quality standards offering, allows Covind to offer a product that is perfectly in line with the expectations of the repairs players and the needs of the most demanding drivers. The Covind rear mirrors are approved and certified. They are absolutely equivalent to OEM and perfectly interchangeable with the original ones. The materials and parts that we use, the attention paid to the glass processing (backing, reflection surface protection, final cleaning and polishing) are a guarantee in terms of functionality and long lasting.

Covind für bessere Sicht

Covind spezialisiert im Bereich Karosserie Ersatzteile für Nutzfahrzeuge und Transporter, nach der jüngsten Akquisition von neuen Industriebetrieben, hat entschieden, eine neue Produktlinie "Rückspiegel" im Programm aufzunehmen. Es ist eine neue und spezifische Linie, durchgedachte und eingeführt und als Ergänzung der breiten Palette und Wartung der Modelle durch die europäischen Hersteller für Fahrzeuge (DAF, IVECO, MAN, MERCEDES-BENZ, RENAULT, SCANIA und VOLVO) herzustellen. Covind hat das Projekt-Know-how, die innovativen Technologien, die neben dem ausgezeichneten Qualitätsstandards angeboten wird. Covind Produkte sind perfekt in Einklang mit den Erwartungen von Reparaturen und die Bedürfnisse dem anspruchsvollsten Fahrer bietet. Die Covind Spiegel sind geprüft und zertifiziert. Sie sind absolut gleichwertig dem Originalteil und austauschbar mit den Originalen. Die Materialien und die Teile, die wir verwenden, beziehen sich auf die Aufmerksamkeit auf die Verarbeitung von Glas (Spiegelbelegung, Oberflächenschutz, Polieren und Endreinigung) und sind eine Garantie in Bezug auf Funktionalität und Langlebigkeit.

COVIND

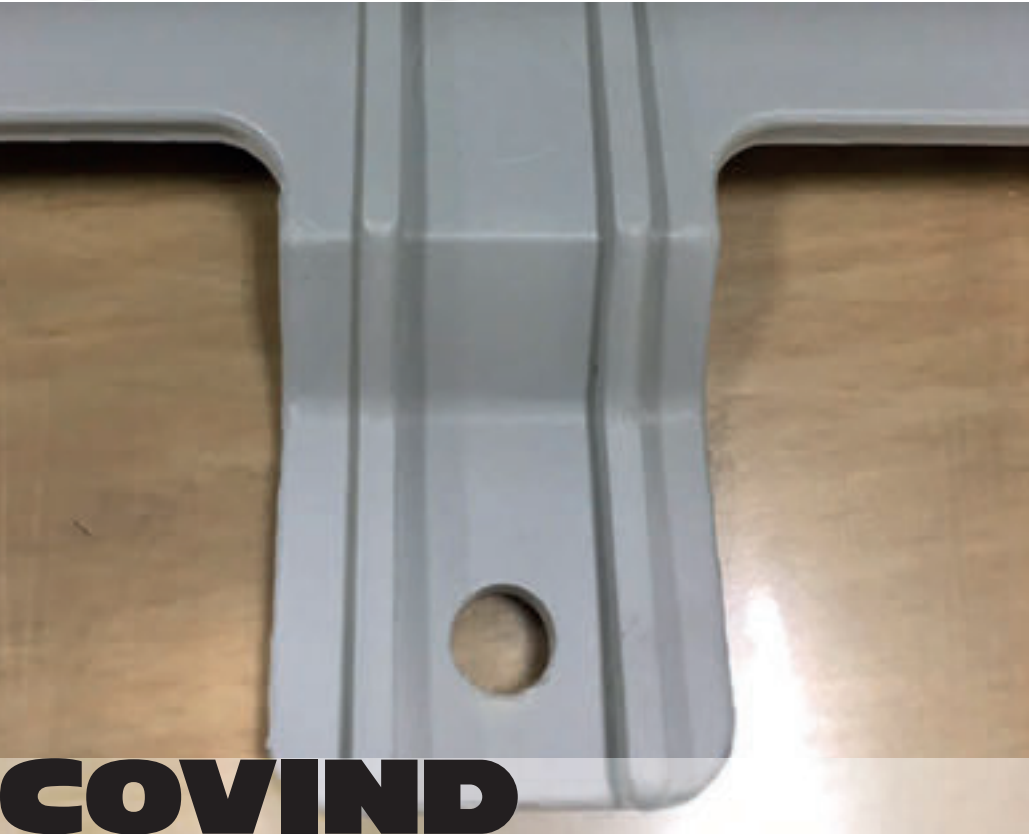

COVIND

Same as original sample

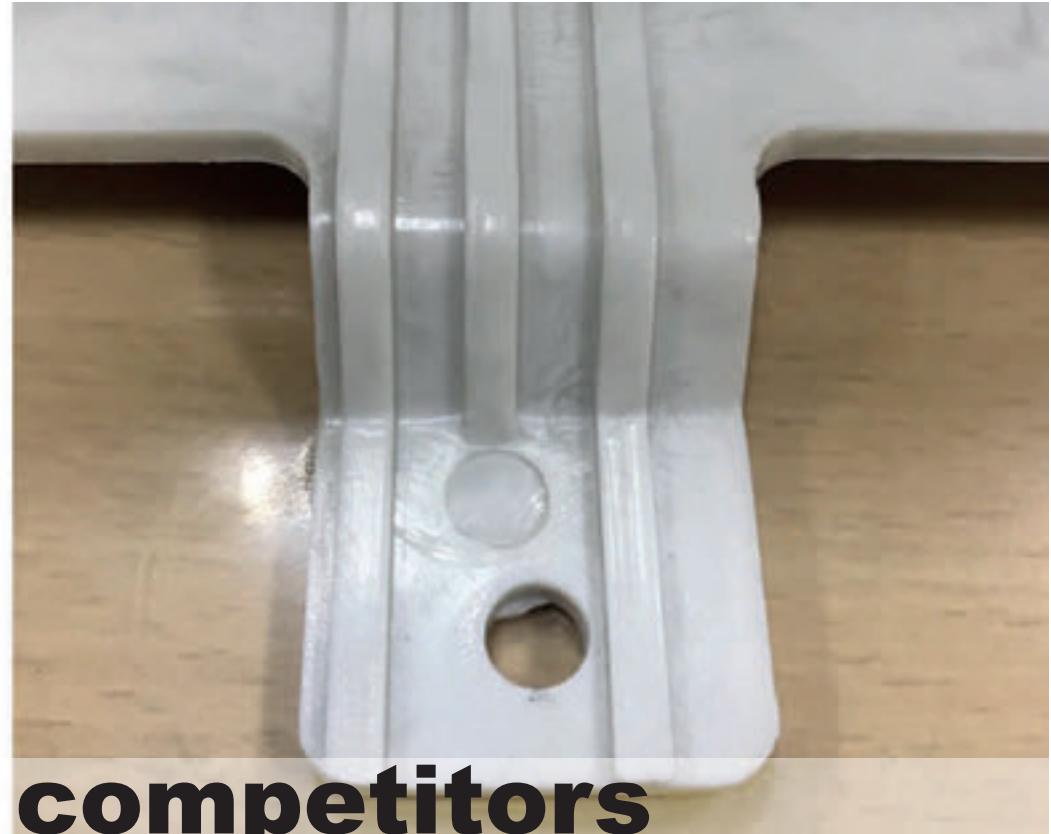

competitors

Design flaw, less durable
(safety/durability problem)

QUALITY



COVIND

With clips



competitors

Without clips (additional cost)

COVIND

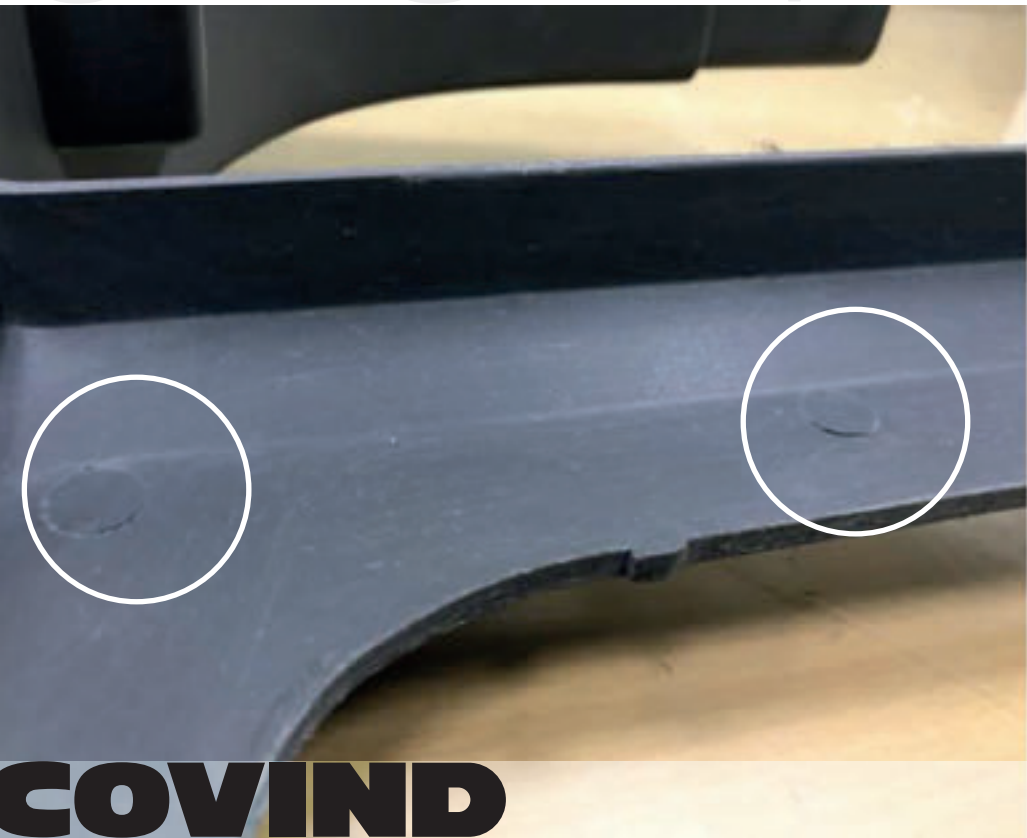

COVIND

Smooth cutting



competitors

Cutting incomplete

QUALITY

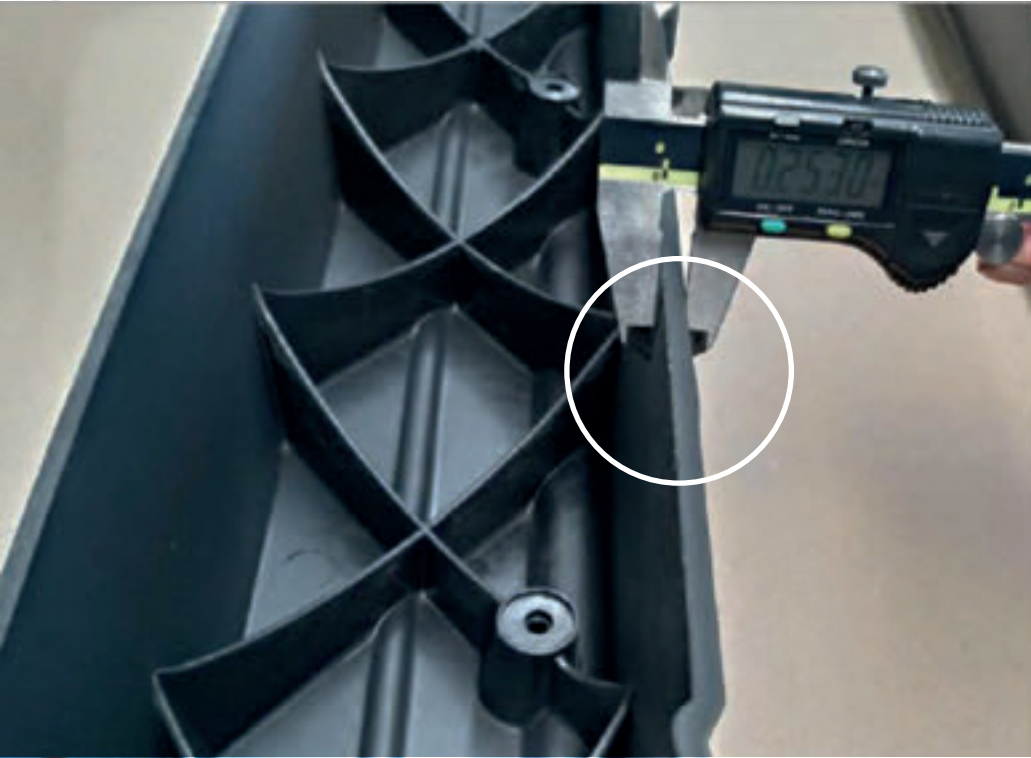

COVIND

Thickness: 6.43 mm

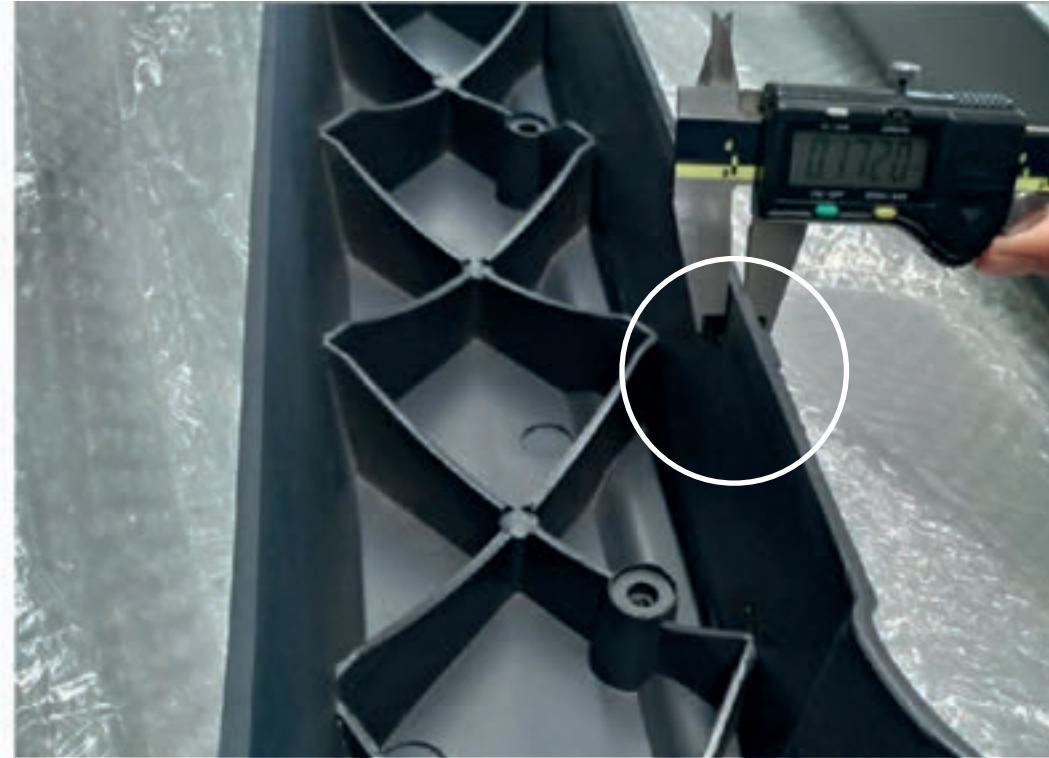

competitors

Thickness: 4,37 mm

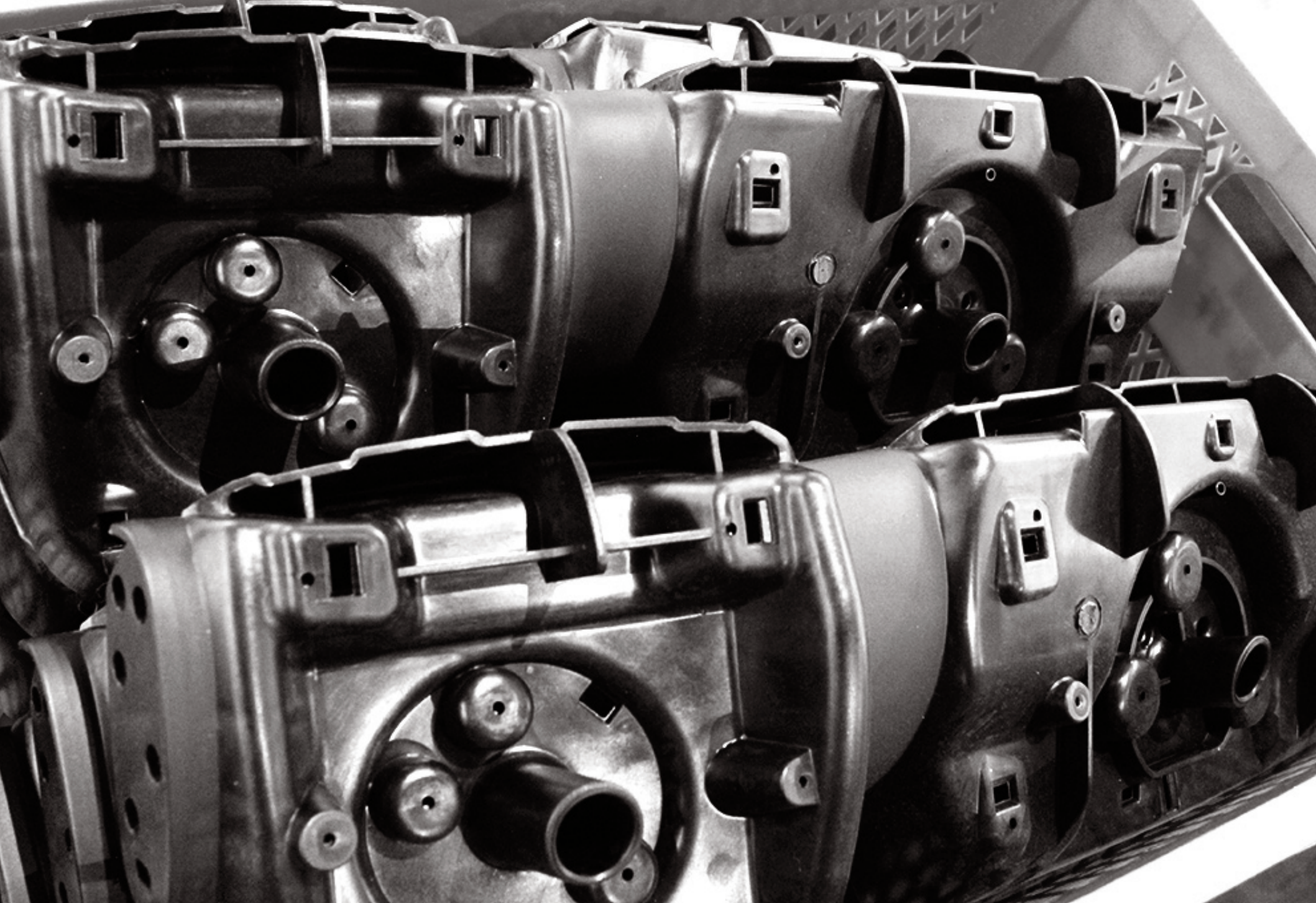

INDEX

INTRO 16

LEGENDA

INTRO 19

REGULATION

INTRO 21 OEM.COVID

INTRO 33 COVIND.OEM

CROSS REFERENCE

1

veicoli industriali
truck
lkw

DAF

23

veicoli commerciali
light commercial vehicles
transporter

FIAT.CITROËN.PEUGEOT

69

veicoli commerciali
light commercial vehicles
transporter

132

dispositivo di comando
control device
Türmodul

140

veicoli industriali
truck
lkw

IVECO

169

veicoli industriali
truck
lkw

MAN

187

veicoli industriali
truck
lkw

MERCEDES-BENZ

213

veicoli industriali
truck
lkw

RENAULT

231

veicoli industriali
truck
lkw

SCANIA

245

veicoli industriali
truck
lkw

VOLVO

LEGENDA



Guida sinistra
Left-hand drive
Linkslenkung



Guida destra
Right-hand drive
Rechtslenkung



Guida destra/sinistra
Right and left-hand drive
Rechts-und Linkslenkung



Braccio corto [S] - destro
Short arm - right
Kurzer Spiegelarm, rechts



Braccio corto [S] - sinistro
Short arm - left
Kurzer Spiegelarm, links



Braccio medio [M] - destro
Middle arm- right
Mittlerer Spiegelarm, rechts



Braccio medio [M] - sinistro
Middle arm - left
Mittlerer Spiegelarm, links



Braccio lungo [L] - destro
Long arm - right
Langer Spiegelarm, rechts



Braccio lungo [L] - sinistro
Long arm - left
Langer Spiegelarm, links



Lato sinistro
Left side
Links einsetzbar



Lato destro
Right side
Rechts einsetzbar



Lato destro/sinistro
Right/left side
Links/rechts einsetzbar



Braccio PP e Fibra di vetro
PP+GF mirror arm
Spiegelarm aus PP und Glasfaser



Braccio integrato
Integrated arm
Integrierten Arm



Braccio in acciaio
Steel arm
Spiegelarm aus Stahl



Braccio in alluminio
Aluminium arm
Spiegelarm aus Aluminium



Materiale: ABS
Material: ABS
Kunststoff ABS



Materiale: ASA
Material: ASA
Kunststoff ASA



Colore Nero
Color Black
Farbe Schwarz



Colore Grigio
Color Grey
Farbe Grau



Colore Silver
Color Silver
Farbe Silber



Colore Nero e Grigio
Color Black/Grey
Farbe Schwarz/Grau



Curvo
Convex
Gewölbtes Glas



Doppio specchio
Double glass
Zweispiegel



Regolazione elettrica
Remote control
Elektrisch verstellbar



Regolazione manuale
Manual control
Manuell verstellbar



Raggio 1200 di convessità specchio principale
Mirror glass bend radius: 1200
Wölbungsradius des Spiegelglases 1200



Raggio di convessità specchio ausiliario
Mirror glass bend radius: 300
Wölbungsradius des Weitwinkelspiegelglases 300



Classe II. Retrovisore principale
Class II. Main mirror
Klasse II. Hauptspiegel



Classe IV. Retrovisore principale/ausiliario
Class IV. Main/auxiliary mirror
Klasse IV. Hauptspiegel/Weitwinkelspiegel



Classe III. Retrovisore ausiliario
Class III. Auxiliary mirror
Klasse III. Weitwinkelspiegel



Specchio guardaruota
Roof mirror
Rampenspiegel



Specchio guardaruota frontale
Front-under-mirror
Frontspiegel



Superiore
Top
Höher



Centrale
Central
Zentral



Inferiore
Bottom
Unter



Braccio con copribraccio inferiore
Arm with lower cover
kompletter Spiegelarm mit unteren Haltebock



Braccio completo di copribraccio superiore e inferiore
Arm with upper and lower cover
kompletter Spiegelarm mit oberen und unteren Haltebock



Braccio completo di supporto superiore
Arm with upper bracket
kompletter Spiegelarm mit oberen Haltebock



Riscaldato (sbrinamento)
Heated
Spiegel beheizt (Entfrostung)



Braccio con cavo per movimento elettrico
Arm with electric wire
Spiegelarm mit Steuerkabel



Braccio con cavo per riscaldamento 24 V
Arm with heat wire 24 V
Spiegelarm mit Heizkabel



Sistema di bloccaggio
Blocking System
Haltebock



Vetro specchio con supporto
Mirror glass unit
Glas mit Spiegelhalter



Ribaltamento elettrico
Electrically foldable
Elektrisch einklappbar



Luce di direzione. Lente trasparente/arancione (W)
Direction lamp. Clear/orange lens (W)
Blinkleuchte, durchsichtige/orange Linse (W)



Luce di direzione. Lente fumè/arancione (W)
Direction lamp. Smoky/orange lens (W)
Blinkleuchte, auchige/orange Linse (W)



Luce di direzione. Lente trasparente (W)
Direction lamp. Clear lens (W)
Blinkleuchte, durchsichtige Linse (W)

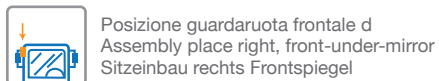

Posizione guardaruota frontale d
Assembly place right, front-under-mirror
Sitzeinbau rechts Frontspiegel

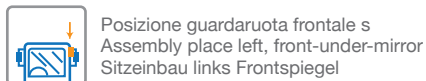

Posizione guardaruota frontale s
Assembly place left, front-under-mirror
Sitzeinbau links Frontspiegel

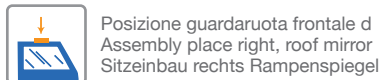

Posizione guardaruota frontale d
Assembly place right, roof mirror
Sitzeinbau rechts Rampenspiegel

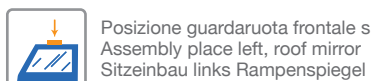

Posizione guardaruota frontale s
Assembly place left, roof mirror
Sitzeinbau links Rampenspiegel

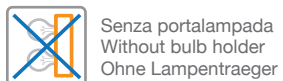

Senza portalamпада
Without bulb holder
Ohne Lampentraeger



Sonda
Sensor
Sensor



Antenna
Antenna
Antenne

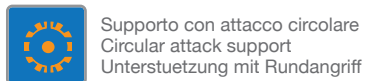

Supporto con attacco circolare
Circular attack support
Unterstützung mit Rundangriff



Fornito smontato
Unassembled
Zerlegte Lieferung

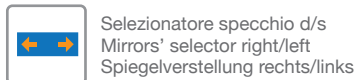

Selezionatore specchio d/s
Mirrors' selector right/left
Spiegelverstellung rechts/links

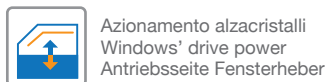

Azionamento alzacristalli
Windows' drive power
Antriebsseite Fensterheber



Retroilluminato
Courtesy lighted
Rueckbeleuchtet



Cabina bassa
Low Cab
niedrige Kabine



Cabina alta
High Cab
Höhe Kabine

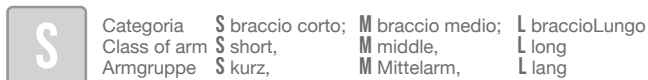

Categoria **S** braccio corto; **M** braccio medio; **L** braccioLungo
Class of arm **S** short, **M** middle, **L** long
Armgruppe **S** kurz, **M** Mittelarm, **L** lang



Veicoli Commerciali
LCV
Transporter



Dispositivi di comando
Control devices
Betaetigungstasten

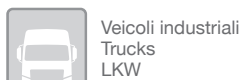

Veicoli industriali
Trucks
LKW

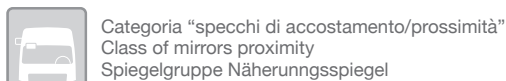

Categoria "specchi di accostamento/prossimità"
Class of mirrors proximity
Spiegelgruppe Näherungsspiegel



* L'OEM fornisce R400-R1800, COVIND R300-R1200 come da normativa vigente. L'indicazione "*" nel codice OEM ha pertanto il solo scopo di aiutare il cliente nell'identificazione del prodotto Covind equivalente.

* OE supplies R1800-R400 while COVIND R1200-R300 according to the valid Regulation. The symbol "*" near the OEM code is used only for comparison purposes helping the customer to properly identify the equivalent item.

* OEM beliefer R1800-R400 während COVIND liefern in R1200-R300 die Europa normative folgend. Die Angabe "*" im Original-Referenz dient dazu, dem Kunden zu helfen, den Covind passenden Produkt zu ermitteln.

NORMATIVA . REGULATION . VORSCHRIFT

Secondo le direttive:

CE 2003/97 valida dal 01/2007

CE 2007/38 valida da 04/2009

With reference to:

2003/97/EC Regulation valid from January 2007

2007/38/EC Regulation valid from April 2009

Gemäß EG-Verordnung:

2003/97/EC Gültig ab Januar 2007

2007/38/EC Gültig ab April 2009

A Sistema specchio completo (II+IV+Braccio)
Complete Mirror (Class II+IV+arm)
Komplettspiegel (Klasse II+IV+Arm)

B Unità specchio (II/IV)
Mirror unit (Class II/Class IV)
Spiegeleinheit (Klasse II/IV)

C Componenti di ricambio
Spare parts
Ersatzteile

Codice Covind
Covind code
Covind Nr.

Codici Originali
O.E.M. Ref.
OE Nummer

Posizione Specchio
Mirror position
Einsetzung des Spiegels

- Particolare presente in assortimento Covind;
Item in Covind Range
Teil in unserer Produktpalette
- Particolare non presente in assortimento Covind
Item not in Covind Range
Teil nicht in unserer Produktpalette

Numero di Omologazione
CE number
Homologations-Nr.

Model	OE Ref.	Dimensions (mm)	CE Number
560/500	39070001 (3907304010), 3904369901, 3904190201	226x472 mm	E4-024098
560/500	39070001, 3904190201, 3904190202, 3904190203	226x472 mm	E4-024099
560/504	3904190201	240x382 mm	-
565/500	3904190201, 3904190202	242x392 mm	-

Dimensioni particolare (larghezza x altezza)
Item dimensions (Width x Height)
Abmessungen des Teiles (Länge * Höhe)

Brand

REGULATION

Secondo le direttive:

CE 2003/97 valida dal 01/2007

CE 2007/38 valida da 04/2009

With reference to:

2003/97/EC Regulation valid from January 2007

2007/38/EC Regulation valid from April 2009

Gemäß EG-Verordnung:

Gültig ab Januar 2007

Gültig ab April 2009

Guida
Drive
Lenkung

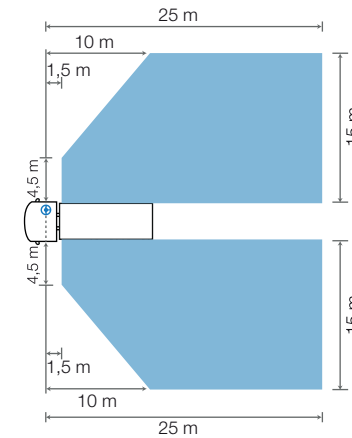
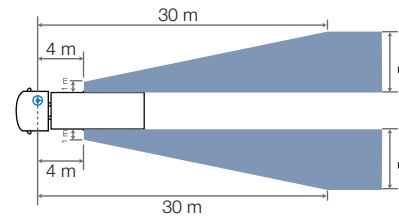
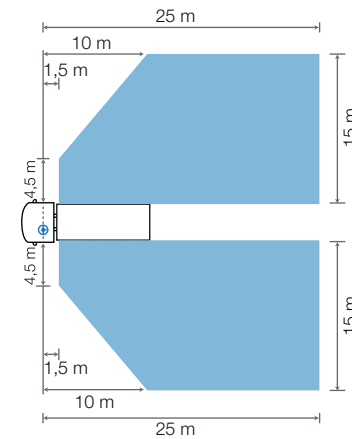
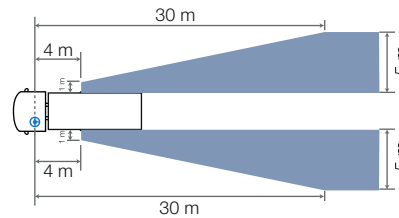

Raggio di convessità degli specchi
Radius of dishing of mirror glass
Wölbungsradius des Spiegelglases

IV VI V

II I
III

CONVESSITÀ
CONVEXIDAD
WÖLBUNG

VETRO PIANO
FLAT GLASS
FLACHGLAS



OEM.COVID

TABELLE COMPARATIVE CROSS REFERENCE KORRESPONDENZTABELLE

Cod. Originale O.E.M. Ref. OE Nummer	Cod. Covind Covind Ref. Covind Teilnummer	Pag.Cat. Page Cat. Seite
CITROËN		
815420	025/502	28
815422	025/501	26
815423	025/503	30
815425	025/506	36
815427	025/514	62
815428	025/508	40
815429	025/516	44
815430	025/510	54
815431	025/504	32
815439	025/512	58
815441	025/520	52
815456	025/515	64
815458	025/519	50
815459	025/511	56
815463	025/505	34
815464	025/517	46
815465	025/509	42
815466	025/513	60
815467	025/507	38
815469	025/521	66
815477	025/518	48
1613688980	025/500	24
1613689080	025/518	48
1613689180	025/514	62
1613689280	025/502	28
1613689380	025/516	44

Cod. Originale O.E.M. Ref. OE Nummer	Cod. Covind Covind Ref. Covind Teilnummer	Pag.Cat. Page Cat. Seite
1613689480	025/510	54
1613689580	025/504	32
1613690380	025/512	58
1613690580	025/520	52
1613691880	025/506	36
1613691980	025/508	40
1613692280	025/501	26
1613692480	025/515	64
1613692580	025/503	30
1613692680	025/519	50
1613692780	025/511	56
1613693180	025/505	34
1613693280	025/517	46
1613693380	025/513	60
1613693480	025/509	42
1613693580	025/507	38
1613693780	025/521	66
1635685380	025/505	34
6325H0	025/561	27, 31
6325H1	025/560	25, 29, 53
6325H3	025/563	35, 39, 43, 47, 51, 57, 61, 65, 67
6325H4	025/562	33, 37, 41, 45, 49, 55, 59, 63
8151LG	025/551	27, 39, 65, 67
8151LH	025/550	25, 37, 49, 53, 63
8151LI	025/556	31, 35, 43, 47, 51, 57, 61

Cod. Originale O.E.M. Ref. OE Nummer	Cod. Covind Covind Ref. Covind Teilnummer	Pag.Cat. Page Cat. Seite
8151LK	025/555	29, 33, 41, 45, 55, 59
8151LL	025/553	27, 39, 65, 67
8151LN	025/552	25, 37, 49, 53, 63
8151LP	025/558	31, 35, 43, 47, 51, 57, 61
8151LQ	025/557	29, 33, 41, 45, 55, 59
8153NL	025/506	36
8153NN	025/518	48
8153NP	025/514	62
8153NQ	025/508	40
8153NR	025/516	44
8153NS	025/510	54
8153NT	025/504	32
8153PE	025/512	58
8153PH	025/515	64
8153PK	025/519	50
8153PL	025/511	56
8153PP	025/505	34
8153PQ	025/517	46
8153PR	025/513	60
8153PS	025/509	42
8153PT	025/507	38
8153PW	025/521	66
8153PY	025/520	52
8153S2	025/520	52
8153W0	025/518	48
8153W1	025/514	62
8153W2	025/516	44

* OEM R1800_COVID R1200 | OEM R400_COVID R300 (view legenda)

OEM.COVID

TABELLE COMPARATIVE CROSS REFERENCE KORRESPONDENZTABELLE

Cod. Originale O.E.M. Ref. OE Nummer	Cod. Covind Covind Ref. Covind Teilnummer	Pag.Cat. Page Cat. Seite
8153W3	025/510	54
8153W4	025/504	32
8153X2	025/512	58
8153X4	025/515	64
8153X6	025/511	56
8153X9	025/517	46
8153Y0	025/513	60
8153Y2	025/507	38
8153Y4	025/521	66
8153Y5	025/500	24
8153Y6	025/502	28
8153Y7	025/501	26
8153Y8	025/503	30
8153ZZ	025/500	24
8154KP	025/500	24
8154KQ	025/518	48
8154KR	025/514	62
8154KS	025/502	28
8154KT	025/516	44
8154KV	025/510	54
8154KW	025/504	32
8154KY	025/520	52
8154LQ	025/506	36
8154LR	025/508	40
8154LT	025/501	26
8154LW	025/515	64
8154LX	025/503	30

Cod. Originale O.E.M. Ref. OE Nummer	Cod. Covind Covind Ref. Covind Teilnummer	Pag.Cat. Page Cat. Seite
8154LY	025/519	50
8154LZ	025/511	56
8154NC	025/505	34
8154NE	025/517	46
8154NF	025/513	60
8154NG	025/509	42
8154NH	025/507	38
8154NK	025/521	66
8154PH	025/512	58
DAF		
1397137	XF0/503	16
1409576	PRM/513	5, 21, 217, 221, 225, 229, 249, 261
1409581	PRM/512	3, 19, 215, 219, 223, 227, 247, 259
1425105	XF0/525	* 14, 16
1425108	XF0/524	* 14
1425109	XF0/504	* 15, 17
1425111	XF0/505	* 15
1425113	XF0/507	15, 17
1425114	XF0/508	15
1425116	XF0/513	17
1425118	XF0/512	15
1610182	XF0/505	15
1610184	XF0/525	* 14, 16
1610187	XF0/524	* 14
1610189	XF0/524	14

Cod. Originale O.E.M. Ref. OE Nummer	Cod. Covind Covind Ref. Covind Teilnummer	Pag.Cat. Page Cat. Seite
1610190	XF0/504	* 15, 17
1610191	XF0/505	* 15
1610263	XF0/503	16
1644323	XF5/512	7, 11
1644324	XF5/513	9, 13
1644325	XF5/506	7, 9, 11, 13
1644326	XF5/505	7, 9, 11, 13
1659248	XF5/506	7, 9, 11, 13
1659249	XF5/505	7, 9, 11, 13
1670877	XF0/524	* 14
1685330	XF5/502	7, 9, 11, 13
1685331	XF5/503	7, 9, 11, 13
1689347	XF5/507	6, 8, 10, 12
1689348	XF5/509	6, 8, 10, 12
1700265	LF0/503	20, 228, 260
1700269	LF0/502	18, 226, 258
1700303	LF0/501	4, 216, 248
1700306	LF0/500	2, 214, 246
1704604	LF0/500	2, 214, 246
1704605	LF0/502	18, 226, 258
1733892	PRM/509	5, 217, 221, 225, 249
1733893	PRM/508	3, 215, 219, 223, 247
1735519	LF0/513	4, 20, 216, 228, 248, 260
1735520	LF0/512	2, 18, 214, 226, 246, 258
1736865	LF0/504	3, 19, 215, 227, 247, 259
1736879	LF0/505	5, 21, 217, 229, 249, 261
1736883	LF0/507	3, 5, 19, 21, 215, 217,

OEM.COVID

TABELLE COMPARATIVE CROSS REFERENCE KORRESPONDENZTABELLE

Cod. Originale O.E.M. Ref. OE Nummer	Cod. Covind Covind Ref. Covind Teilnummer	Pag.Cat. Page Cat. Seite
		227, 229, 247, 249, 259, 261
1736884	LF0/506	3, 5, 19, 21, 215, 217, 227, 229, 247, 249, 259, 261
1736923	PRM/512	3, 19, 215, 219, 223, 227, 247, 259
1736924	PRM/513	5, 21, 217, 221, 225, 229, 249, 261
1736953	LF0/508	19, 227, 259
1736954	LF0/509	21, 229, 261
1737933	PRM/504	3, 5, 19, 21, 215, 217, 219, 221, 223, 225, 227, 229, 247, 249, 259, 261
1781227	LF0/511	4, 20, 216, 228, 248, 260
1781228	LF0/510	2, 18, 214, 226, 246, 258
1788487	CF0/502	7
1788972	CF0/503	9
1788976	CF0/502	7
1808561	CF0/501	8
1812859	CF0/503	9
1812862	XF5/509	6, 8, 10, 12
1813005	CF0/500	6
1817860	XF5/507	6, 8, 10, 12
1818353	CF0/502	7
1952141	CF0/501	8
1952146	CF0/500	6

Cod. Originale O.E.M. Ref. OE Nummer	Cod. Covind Covind Ref. Covind Teilnummer	Pag.Cat. Page Cat. Seite
-	PRM/522	3, 19, 215, 219, 223, 227, 247, 259
-	PRM/523	5, 21, 217, 221, 225, 229, 249, 261
-	XF0/502	14
-	XF5/500	10
-	XF5/501	12
FIAT		
71748244	025/551	27, 39, 65, 67
71748245	025/550	25, 37, 49, 53, 63
71748246	025/556	31, 35, 43, 47, 51, 57, 61
71748247	025/555	29, 33, 41, 45, 55, 59
71748248	025/553	27, 39, 65, 67
71748249	025/552	25, 37, 49, 53, 63
71748250	025/558	31, 35, 43, 47, 51, 57, 61
71748251	025/557	29, 33, 41, 45, 55, 59
71748252	025/561	27, 31
71748253	025/560	25, 29, 53
71748254	025/563	35, 39, 43, 47, 51, 57, 61, 65, 67
71748255	025/562	33, 37, 41, 45, 49, 55, 59, 63
735424394	025/500	24
735424395	025/518	48
735424396	025/514	62
735424397	025/502	28
735424398	025/516	44

Cod. Originale O.E.M. Ref. OE Nummer	Cod. Covind Covind Ref. Covind Teilnummer	Pag.Cat. Page Cat. Seite
735424399	025/510	54
735424400	025/504	32
735424406	025/512	58
735424408	025/520	52
735424420	025/501	26
735424422	025/515	64
735424423	025/503	30
735424425	025/511	56
735424432	025/517	46
735424433	025/513	60
735424438	025/507	38
735424440	025/521	66
735440385	025/506	36
735440386	025/518	48
735440387	025/514	62
735440388	025/508	40
735440389	025/516	44
735440390	025/510	54
735440391	025/504	32
735440399	025/512	58
735440401	025/520	52
735440416	025/515	64
735440418	025/519	50
735440419	025/511	56
735440423	025/505	34
735440424	025/517	46
735440425	025/513	60

* OEM R1800_COVID R1200 | OEM R400_COVID R300 (view legenda)

OEM.COVID

TABELLE COMPARATIVE CROSS REFERENCE KORRESPONDENZTABELLE

Cod. Originale O.E.M. Ref. OE Nummer	Cod. Covind Covind Ref. Covind Teilnummer	Pag.Cat. Page Cat. Seite
735440426	025/509	42
735440427	025/507	38
735440429	025/521	66
735480884	025/500	24
735480885	025/518	48
735480886	025/514	62
735480887	025/502	28
735480888	025/516	44
735480889	025/510	54
735480890	025/504	32
735480898	025/512	58
735480900	025/520	52
735480915	025/506	36
735480916	025/508	40
735480931	025/501	26
735480933	025/515	64
735480934	025/503	30
735480935	025/519	50
735480936	025/511	56
735480940	025/505	34
735480941	025/517	46
735480942	025/513	60
735480943	025/509	42
735480944	025/507	38
735480946	025/521	66
735501134	025/512	58
735517038	025/500	24

Cod. Originale O.E.M. Ref. OE Nummer	Cod. Covind Covind Ref. Covind Teilnummer	Pag.Cat. Page Cat. Seite
735517039	025/518	48
735517040	025/514	62
735517041	025/502	28
735517042	025/516	44
735517043	025/510	54
735517044	025/504	32
735517052	025/512	58
735517054	025/520	52
735517067	025/506	36
735517068	025/508	40
735517070	025/501	26
735517072	025/515	64
735517073	025/503	30
735517074	025/519	50
735517075	025/511	56
735517079	025/505	34
735517080	025/517	46
735517081	025/513	60
735517082	025/509	42
735517083	025/507	38
735517085	025/521	66
735620699	025/505	34
735620700	025/508	40
735620706	025/500	24
735620707	025/518	48
735620708	025/514	62
735620709	025/502	28

Cod. Originale O.E.M. Ref. OE Nummer	Cod. Covind Covind Ref. Covind Teilnummer	Pag.Cat. Page Cat. Seite
735620710	025/516	44
735620711	025/510	54
735620712	025/504	32
735620718	025/512	58
735620720	025/520	52
735620732	025/506	36
735620745	025/501	26
735620747	025/515	64
735620748	025/503	30
735620749	025/519	50
735620750	025/511	56
735620752	025/517	46
735620753	025/513	60
735620754	025/509	42
735620755	025/507	38
735620757	025/521	66
735661832	025/505	34
735675485	025/509	42
IVECO		
2997216	060/502	149
2997667	560/509	141, 143, 145, 147, 157, 159, 161
2997668	095/505	141, 143, 145, 147, 157, 159, 161
3800401	D06/501	86
3800402	D06/519	100
3800403	D06/509	94

OEM.COVID

TABELLE COMPARATIVE CROSS REFERENCE KORRESPONDENZTABELLE

Cod. Originale O.E.M. Ref. OE Nummer	Cod. Covind Covind Ref. Covind Teilnummer	Pag.Cat. Page Cat. Seite
3800404	D06/507	92
3800406	D06/516	96
3800409	D06/517	98
3800414	D06/500	84
3800416	D06/504	88
3800423	D06/510	122
3800425	D06/502	118
3800426	D06/513	126
3800427	D06/511	124
3800429	D06/503	120
3800471	D06/566	97
3800472	D06/567	87, 91, 93, 95, 101
3800473	D12/558	119, 123
3800500	D06/557	99
3800501	D06/556	85, 89
3800503	D06/559	121, 125, 127
3801910	D06/555	87, 91, 93, 95, 99, 101, 121, 125, 127
3801911	D06/554	85, 89, 97, 119, 123
3801914	D06/427	87, 91, 93, 95, 99, 101, 109, 113, 117, 121, 125, 127
3801915	D06/426	85, 89, 97, 107, 111, 115, 119, 123
3801926	D06/551	87, 91, 93, 95, 99, 101, 109, 113, 117, 121, 125, 127

Cod. Originale O.E.M. Ref. OE Nummer	Cod. Covind Covind Ref. Covind Teilnummer	Pag.Cat. Page Cat. Seite
3801927	D06/550	85, 89, 97, 107, 111, 115, 119, 123
3801928	D06/553	87, 91, 93, 95, 99, 101, 109, 113, 117, 121, 125, 127
3801929	D06/552	85, 89, 97, 107, 111, 115, 119, 123
42344326	060/500	148
69500478	D06/ 16	136
93190971	060/505	153
93190977	060/504	151
93193203	440/508	155
93924653	038/500	102
93924654	038/501	103
93928072	038/502	128
93928073	038/503	129
93936842	038/507	131
93936843	038/506	130
98472937	060/507	167
98472973	060/507	167
98472998	060/507	167
99457905	060/502	149
99457908	060/500	148
500321136	C39/ 24	138
500325725	C39/503	105
500325726	C39/502	104
504150526	560/501	142

Cod. Originale O.E.M. Ref. OE Nummer	Cod. Covind Covind Ref. Covind Teilnummer	Pag.Cat. Page Cat. Seite
504150527	560/500	140
504150538	560/503	146
504150539	560/502	144, 145
504150551	095/501	158
504150552	095/500	156
504158974	560/505	143, 147, 159, 161
504158975	560/504	141, 145, 157
504158976	095/507	143, 147, 159, 161
504158977	095/506	141, 145, 157
504159282	560/509	141, 143, 145, 147, 157, 159, 161
504159284	560/509	141, 143, 145, 147, 157, 159, 161
504159286	560/509	141, 143, 145, 147, 157, 159, 161
504168236	095/520	164
504168244	095/512	165
504197878	560/509	141, 143, 145, 147, 157, 159, 161
504197879	095/505	141, 143, 145, 147, 157, 159, 161
504224428	095/510	162
504369910	560/501	142
504369961	560/500	140
504369979	095/501	158
504369995	095/500	156
504370048	560/503	146

* OEM R1800_COVID R1200 | OEM R400_COVID R300 (view legenda)

Cod. Originale O.E.M. Ref. OE Nummer	Cod. Covind Covind Ref. Covind Teilnummer	Pag.Cat. Page Cat. Seite
504370055	560/502	144, 145
5801304491	D06/ 16	136
5801334610	560/500	140
5801334614	560/501	142
5801336285	560/503	146
5801336298	560/502	144, 145
5801341206	095/501	158
5801341207	095/500	156
5801367567	D06/510	122
5801367569	D06/502	118
5801367570	D06/513	126
5801367571	D06/511	124
5801367573	D06/503	120
5801367606	D06/501	86
5801367608	D06/519	100
5801367610	D06/509	94
5801367611	D06/507	92
5801367618	D06/516	96
5801367625	D06/517	98
5801367639	D06/500	84
5801367641	D06/504	88
5801399646	D12/ 15	134
5801484207	D12/ 15	134
5801511735	D14/ 15	132
5801552546	D14/509	82
5801552547	D14/508	80
5801552548	D16/501	72

Cod. Originale O.E.M. Ref. OE Nummer	Cod. Covind Covind Ref. Covind Teilnummer	Pag.Cat. Page Cat. Seite
5801552549	D16/500	70
5801552552	D14/501	76
5801552553	D14/500	74
5801552556	D14/505	78
5801580201	560/501	142
5801580202	560/500	140
5801580228	560/503	146
5801580230	560/502	144, 145
5801580261	095/501	158
5801580263	095/500	156
5801580275	095/503	160
5801679489	D14/502	114
5801679491	D16/511	112
5801679492	D16/510	110
5801681268	D16/503	108
5801687143	D14/503	116
5801687178	D16/502	106
5801736695	D06/513	126
5801736697	D06/502	118
5801736702	D06/503	120
5801736704	D06/510	122
5801736705	D06/511	124
5801755695	D06/501	86
5801755709	D06/519	100
5801755712	D06/509	94
5801755713	D06/507	92
5801755722	D06/516	96

Cod. Originale O.E.M. Ref. OE Nummer	Cod. Covind Covind Ref. Covind Teilnummer	Pag.Cat. Page Cat. Seite
5801755740	D06/517	98
5801755747	D06/500	84
5801755754	D06/504	88
5801765195	560/501	142
5801765196	560/500	140
5801765315	560/503	146
5801765318	560/502	144, 145
5801765363	095/501	158
5801765364	095/500	156
5801765367	095/503	160
5801765379	095/520	164
5801806044	095/510	162
5801806057	095/511	163
5801822982	D16/558	107, 111, 115
5801822986	D16/560	111, 115
5801822996	D16/557	109, 113, 117
5801822999	D16/555	109, 113, 117
5801823306	D14/550	71, 75, 81
5801823334	D14/530	71, 75, 81
5801823346	D14/552	71, 75, 81
5801823377	D14/554	75, 81
5801823557	D14/553	73, 77, 79, 83
5801823572	D14/531	73, 77, 79, 83
5801823582	D14/555	77, 79, 83
5801823777	D16/563	73
5801823823	D16/562	71
5801823992	D14/551	73, 77, 79, 83

OEM.COVID

TABELLE COMPARATIVE CROSS REFERENCE KORRESPONDENZTABELLE

Cod. Originale O.E.M. Ref. OE Nummer	Cod. Covind Covind Ref. Covind Teilnummer	Pag.Cat. Page Cat. Seite
5801876636	095/508	166
5802028033	D14/509	82
5802028034	D14/508	80
5802028036	D14/501	76
5802028037	D14/500	74
5802028039	D14/505	78
5802029582	D16/501	72
5802029650	D16/500	70
5802029773	D14/502	114
5802029774	D14/503	116
5802029776	D16/511	112
5802029798	D16/510	110
5802029799	D16/503	108
5802029805	D16/502	106
5802031837	D06/501	86
5802031838	D06/519	100
5802031841	D06/509	94
5802031845	D06/507	92
5802031849	D06/516	96
5802031923	D06/517	98
5802031928	D06/505	90
5802031932	D06/500	84
5802031936	D06/504	88
5802032040	D06/513	126
5802032043	D06/510	122
5802032045	D06/511	124
5802032046	D06/502	118

Cod. Originale O.E.M. Ref. OE Nummer	Cod. Covind Covind Ref. Covind Teilnummer	Pag.Cat. Page Cat. Seite
5802032049	D06/503	120
5802287173	095/508	166
5802322000	095/510	162
5802322008	095/511	163
5802495899	D16/565	71, 81
5802495900	D16/566	73, 83
5802495901	D14/508	80
5802495902	D14/509	82
5802495903	D16/501	72
5802495904	D16/500	70
MAN		
81637306430	XXL/523	* 172, 184
81637306432	XXL/522	* 170, 182
81637306443	XXL/525	* 172, 184
81637306444	XXL/524	* 170, 182
81637306480	XXL/523	172, 184
81637306481	XXL/522	170, 182
81637306512	XXL/525	172, 184
81637306513	XXL/524	170, 182
81637306549	TGS/501	176
81637306550	TGS/500	174
81637306560	TGX/503	180
81637306561	TGX/502	178
81637306755	TGS/501	176
81637306756	TGX/503	180
81637306762	TGS/500	174
81637306765	TGX/502	178

Cod. Originale O.E.M. Ref. OE Nummer	Cod. Covind Covind Ref. Covind Teilnummer	Pag.Cat. Page Cat. Seite
81637316431	MLX/507	173
81637316467	MLX/506	171
81637316557	MLX/507	173
81637316560	MLX/506	171
81637316613	XXL/513	185
81637316614	XXL/512	183
81637316617	XXL/513	185
81637316618	XXL/512	183
81637320054	XXL/507	173, 185
81637320055	XXL/506	171, 183
81637320056	XXL/502	171, 183
81637320057	XXL/503	173, 185
81637320059	XXL/507	173, 185
81637320060	XXL/506	171, 183
81637320061	XXL/503	173, 185
81637320062	XXL/502	171, 183
81637320063	XXL/507	173, 185
81637320064	XXL/506	171, 183
81637320065	XXL/503	173, 185
81637320066	XXL/502	171, 183
81637336034	XXL/500	* 171, 173, 183, 185
81637336037	XXL/501	* 171, 173, 183, 185
81637336049	XXL/500	171, 173, 183, 185
81637336053	XXL/500	* 171, 173, 183, 185
81637336057	XXL/501	171, 173, 183, 185
81637336071	TGS/502	175, 177, 179, 181
81637336072	TGS/504	175, 179

* OEM R1800_COVID R1200 | OEM R400_COVID R300 (view legenda)

OEM.COVID

TABELLE COMPARATIVE CROSS REFERENCE KORRESPONDENZTABELLE

Cod. Originale O.E.M. Ref. OE Nummer	Cod. Covid Covid Ref. Covid Teilnummer	Pag.Cat. Page Cat. Seite
81637336073	TGS/505	177, 181
-	MLX/500	170
-	MLX/501	172, 173
-	XXL/508	182
-	XXL/509	184
MERCEDES-BENZ		
0008100379	973/511	188, 190
0008101579	973/516	192
0008101679	973/518	192, 194
0008101879	973/517	194
0008102079	973/517	194
0008102179	973/516	192
0008102479	973/518	192, 194
0008110361	973/515	191
0008110461	973/514	189
0008111307	941/504	189, 191, 197, 199, 205, 207
0008112007	973/507	193, 195
0018104414	941/507	207
0018104514	941/506	205
0018109116	941/509	196, 198, 204, 206
0018109216	941/508	188, 190, 196, 198, 204
0018109714	973/513	195
0018109814	973/512	193
00018113433	973/504	* 188, 189, 190, 191
0018116033	941/503	189, 191, 197, 199, 205
0018119933	973/505	192, 193, 194, 195

Cod. Originale O.E.M. Ref. OE Nummer	Cod. Covid Covid Ref. Covid Teilnummer	Pag.Cat. Page Cat. Seite
0028100814	943/507	199
0028100816	973/510	211
0028100914	943/506	197
0028102416	943/509	203
0028102516	943/508	201
0028103214	943/527	203
0028103314	943/526	201
0028110033	973/506	192, 193, 194, 195
0028110433	941/502	197, 199, 205, 207
0028113333	943/497	203
0028113433	943/496	201
0028113733	943/493	203
0028113833	943/492	201
9408102616	973/510	211
9408107316	940/511	209
9408107516	940/510	208
9418110007	941/514	197, 199, 205, 207
9438105116	943/522	210
9438105816	943/503	202
9438106016	943/502	200
9438110107	943/513	201, 203
9438110207	943/514	201, 203
9438110307	943/505	203
9438110407	943/504	201
9738100314	973/509	191
9738100414	973/508	189
-	941/500	204

Cod. Originale O.E.M. Ref. OE Nummer	Cod. Covid Covid Ref. Covid Teilnummer	Pag.Cat. Page Cat. Seite
-	941/501	206
-	943/500	196
-	943/501	198
-	973/500	188
-	973/501	190
-	973/502	192
-	973/503	194
PEUGEOT		
815420	025/502	28
815422	025/501	26
815423	025/503	30
815425	025/506	36
815427	025/514	62
815428	025/508	40
815429	025/516	44
815430	025/510	54
815431	025/504	32
815439	025/512	58
815441	025/520	52
815456	025/515	64
815458	025/519	50
815459	025/511	56
815463	025/505	34
815464	025/517	46
815465	025/509	42
815466	025/513	60
815467	025/507	38

Cod. Originale O.E.M. Ref. OE Nummer	Cod. Covind Covind Ref. Covind Teilnummer	Pag.Cat. Page Cat. Seite
815469	025/521	66
815477	025/518	48
1613688980	025/500	24
1613689080	025/518	48
1613689180	025/514	62
1613689280	025/502	28
1613689380	025/516	44
1613689480	025/510	54
1613689580	025/504	32
1613690380	025/512	58
1613690580	025/520	52
1613691880	025/506	36
1613691980	025/508	40
1613692280	025/501	26
1613692480	025/515	64
1613692580	025/503	30
1613692680	025/519	50
1613692780	025/511	56
1613693180	025/505	34
1613693280	025/517	46
1613693380	025/513	60
1613693480	025/509	42
1613693580	025/507	38
1613693780	025/521	66
1635685380	025/505	34
6325H0	025/561	27, 31
6325H1	025/560	25, 29, 53

Cod. Originale O.E.M. Ref. OE Nummer	Cod. Covind Covind Ref. Covind Teilnummer	Pag.Cat. Page Cat. Seite
6325H3	025/563	35, 39, 43, 47, 51, 57, 61, 65, 67
6325H4	025/562	33, 37, 41, 45, 49, 55, 59, 63
8151LG	025/551	27, 39, 65, 67
8151LH	025/550	25, 37, 49, 53, 63
8151LI	025/556	31, 35, 43, 47, 51, 57, 61
8151LK	025/555	29, 33, 41, 45, 55, 59
8151LL	025/553	27, 39, 65, 67
8151LN	025/552	25, 37, 49, 53, 63
8151LP	025/558	31, 35, 43, 47, 51, 57, 61
8151LQ	025/557	29, 33, 41, 45, 55, 59
8153NL	025/506	36
8153NN	025/518	48
8153NP	025/514	62
8153NQ	025/508	40
8153NR	025/516	44
8153NS	025/510	54
8153NT	025/504	32
8153PE	025/512	58
8153PH	025/515	64
8153PK	025/519	50
8153PL	025/511	56
8153PP	025/505	34
8153PQ	025/517	46
8153PR	025/513	60
8153PS	025/509	42

Cod. Originale O.E.M. Ref. OE Nummer	Cod. Covind Covind Ref. Covind Teilnummer	Pag.Cat. Page Cat. Seite
8153PT	025/507	38
8153PW	025/521	66
8153PY	025/520	52
8153S2	025/520	52
8153W0	025/518	48
8153W1	025/514	62
8153W2	025/516	44
8153W3	025/510	54
8153W4	025/504	32
8153X2	025/512	58
8153X4	025/515	64
8153X6	025/511	56
8153X9	025/517	46
8153Y0	025/513	60
8153Y2	025/507	38
8153Y4	025/521	66
8153Y5	025/500	24
8153Y6	025/502	28
8153Y7	025/501	26
8153Y8	025/503	30
8153ZZ	025/500	24
8154KP	025/500	24
8154KQ	025/518	48
8154KR	025/514	62
8154KS	025/502	28
8154KT	025/516	44
8154KV	025/510	54

* OEM R1800_COVID R1200 | OEM R400_COVID R300 (view legenda)

OEM.COVID

TABELLE COMPARATIVE CROSS REFERENCE KORRESPONDENZTABELLE

Cod. Originale O.E.M. Ref. OE Nummer	Cod. Covind Covind Ref. Covind Teilnummer	Pag.Cat. Page Cat. Seite
8154KW	025/504	32
8154KY	025/520	52
8154LQ	025/506	36
8154LR	025/508	40
8154LT	025/501	26
8154LW	025/515	64
8154LX	025/503	30
8154LY	025/519	50
8154LZ	025/511	56
8154NC	025/505	34
8154NE	025/517	46
8154NF	025/513	60
8154NG	025/509	42
8154NH	025/507	38
8154NK	025/521	66
8154PH	025/512	58
RENAULT		
5010578503	PRM/501	220
5010578504	PRM/500	218
5010578505	PRM/529	224
5010578506	PRM/528	222
5010623057	PRM/513	5, 21, 217, 221, 225, 229, 249, 261
5010623058	PRM/512	3, 19, 215, 219, 223, 227, 247, 259
5010623231	LF0/501	4, 216, 248
5010623232	LF0/500	2, 214, 246

Cod. Originale O.E.M. Ref. OE Nummer	Cod. Covind Covind Ref. Covind Teilnummer	Pag.Cat. Page Cat. Seite
5010623246	LF0/503	20, 228, 260
5010623247	LF0/502	18, 226, 258
7420862779	LF0/506	3, 5, 19, 21, 215, 217, 227, 229, 247, 249, 259, 261
7420862795	PRM/504	3, 5, 19, 21, 215, 217, 219, 221, 223, 225, 227, 229, 247, 249, 259, 261
7420862800	LF0/507	3, 5, 19, 21, 215, 217, 227, 229, 247, 249, 259, 261
7420862810	LF0/505	5, 21, 217, 229, 249, 261
7420862815	LF0/504	3, 19, 215, 227, 247, 259
7420903722	PRM/509	5, 217, 221, 225, 249
7420903723	LF0/509	21, 229, 261
7420903727	PRM/508	3, 215, 219, 223, 247
7420903732	LF0/508	19, 227, 259
7420903745	PRM/507	221, 225
7420903746	PRM/506	219, 223
7420903880	PRM/505	219, 221
7420903881	PRM/511	223, 225
7420903882	PRM/503	221
7420903883	PRM/502	219
7420903885	PRM/527	225
7420903887	PRM/526	223
7421326526	LF0/502	18, 226, 258
7421326527	LF0/500	2, 214, 246

Cod. Originale O.E.M. Ref. OE Nummer	Cod. Covind Covind Ref. Covind Teilnummer	Pag.Cat. Page Cat. Seite
7421326550	PRM/500	218
7421326551	PRM/528	222
-	LF0/510	2, 18, 214, 226, 246, 258
-	LF0/512	2, 18, 214, 226, 246, 258
-	LF0/513	4, 20, 216, 228, 248, 260
-	PRM/522	3, 19, 215, 219, 223, 227, 247, 259
-	PRM/523	5, 21, 217, 221, 225, 229, 249, 261
-	PRM/530	218
-	PRM/531	220
-	PRM/532	218
-	PRM/533	220
-	PRM/534	222
-	PRM/535	224
-	PRM/536	222
-	PRM/537	224
-	LF0/511	4, 20, 216, 228, 248, 260
SCANIA		
1346380	144/512	233, 235, 237, 239, 241, 243
1723518	144/505	238
1723519	144/506	240
1732782	144/511	* 236, 242
1732783	144/510	* 234, 240
1765808	144/510	234, 240
1765809	144/511	236, 242

* OEM R1800°_COVID R1200° | OEM R400°_COVID R300° (view legenda)

OEM.COVID

TABELLE COMPARATIVE CROSS REFERENCE KORRESPONDENZTABELLE

Cod. Originale	Cod. Covind	Pag.Cat.
O.E.M. Ref.	Covind Ref.	Page Cat.
OE Nummer	Covind Teilnummer	Seite
1765985	144/501	233, 235, 237, 239, 241, 243
1767265	144/502	235, 237, 241, 243
2425815	144/505	238
2425816	144/506	240
-	144/503	232
-	144/507	242
-	144/508	234
-	144/509	236
VOLVO		
3091750	0FH/513	257
3091751	0FH/512	255
3092854	0FH/506	255, 257
20360810	2FH/502	251, 253
20360811	2FH/508	251, 253
20455995	2FH/504	251, 253
20567685	2FH/504	251, 253
20589788	2FH/503	251, 253, 263, 265
20589798	3FH/509	263, 265
20707874	LF0/503	20, 228, 260
20707881	LF0/501	4, 216, 248
20708110	PRM/513	5, 21, 217, 221, 225, 229, 249, 261
20708230	PRM/512	3, 19, 215, 219, 223, 227, 247, 259
20708303	LF0/502	18, 226, 258
20743983	LF0/500	2, 214, 246

Cod. Originale	Cod. Covind	Pag.Cat.
O.E.M. Ref.	Covind Ref.	Page Cat.
OE Nummer	Covind Teilnummer	Seite
20746401	2FH/502	251, 253
20746402	3FH/511	263, 265
20841436	3FH/508	263, 265
20854564	0FH/506	255, 257
20862779	LF0/506	3, 5, 19, 21, 215, 217, 227, 229, 247, 249, 259, 261
20862795	PRM/504	3, 5, 19, 21, 215, 217, 219, 221, 223, 225, 227, 229, 247, 249, 259, 261
20862800	LF0/507	3, 5, 19, 21, 215, 217, 227, 229, 247, 249, 259, 261
20862810	LF0/505	5, 21, 217, 229, 249, 261
20862815	LF0/504	3, 19, 215, 227, 247, 259
20903722	PRM/509	5, 217, 221, 225, 249
20903723	LF0/509	21, 229, 261
20903727	PRM/508	3, 215, 219, 223, 247
20903732	LF0/508	19, 227, 259
21070768	3FH/509	263, 265
21169974	3FH/511	263, 265
21203311	0FH/507	255, 257
21320300	2FH/504	251, 253
21320365	3FH/509	263, 265
21320404	2FH/503	251, 253, 263, 265
21326527	LF0/500	2, 214, 246
21475603	LF0/502	18, 226, 258

Cod. Originale	Cod. Covind	Pag.Cat.
O.E.M. Ref.	Covind Ref.	Page Cat.
OE Nummer	Covind Teilnummer	Seite
22286149	3FH/505	264
22286155	3FH/504	262
-	0FH/508	254
-	0FH/509	256
-	2FH/500	250
-	2FH/501	252
-	3FH/502	250
-	3FH/503	252
-	3FH/506	262
-	3FH/507	264
-	LF0/510	2, 18, 214, 226, 246, 258
-	LF0/511	4, 20, 216, 228, 248, 260
-	LF0/512	2, 18, 214, 226, 246, 258
-	LF0/513	4, 20, 216, 228, 248, 260
-	PRM/522	3, 19, 215, 219, 223, 227, 247, 259
-	PRM/523	5, 21, 217, 221, 225, 229, 249, 261

* OEM R1800°_COVID R1200° | OEM R400°_COVID R300° (view legenda)

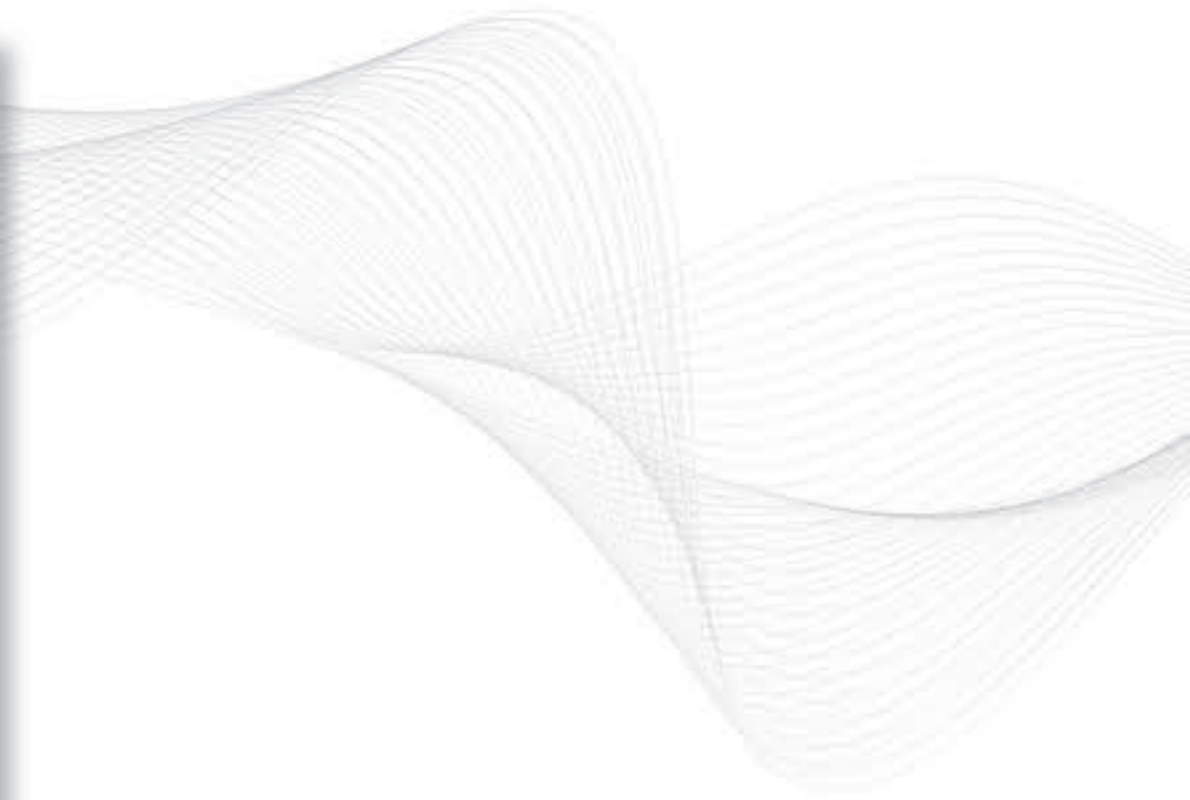

IT Progetto specchi retrovisori. Stampo per corpo specchio

EN Rear - view mirrors project. Mould for mirror body

DE Rückspiegel-Projekt. Stahlform für Spiegelkopf

Cod. Covind Covind Ref. Covind Teilnummer	Cod. Originale O.E.M. Ref. OE Nummer	Pag.Cat. Page Cat. Seite
CITROËN		
025/500	1613688980	24
025/500	8154KP	24
025/500	8153ZZ	24
025/500	8153Y5	24
025/501	1613692280	26
025/501	8154LT	26
025/501	815422	26
025/501	8153Y7	26
025/502	1613689280	28
025/502	8154KS	28
025/502	815420	28
025/502	8153Y6	28
025/503	1613692580	30
025/503	8154LX	30
025/503	815423	30
025/503	8153Y8	30
025/504	1613689580	32
025/504	8154KW	32
025/504	815431	32
025/504	8153NT	32
025/504	8153W4	32
025/505	1635685380	34
025/505	1613693180	34
025/505	8154NC	34
025/505	815463	34
025/505	8153PP	34

Cod. Covind Covind Ref. Covind Teilnummer	Cod. Originale O.E.M. Ref. OE Nummer	Pag.Cat. Page Cat. Seite
025/506	1613691880	36
025/506	8154LQ	36
025/506	815425	36
025/506	8153NL	36
025/507	1613693580	38
025/507	8154NH	38
025/507	815467	38
025/507	8153PT	38
025/507	8153Y2	38
025/508	1613691980	40
025/508	8154LR	40
025/508	815428	40
025/508	8153NQ	40
025/509	1613693480	42
025/509	8154NG	42
025/509	815465	42
025/509	8153PS	42
025/510	1613689480	54
025/510	8154KV	54
025/510	815430	54
025/510	8153NS	54
025/510	8153W3	54
025/511	1613692780	56
025/511	8154LZ	56
025/511	815459	56
025/511	8153PL	56
025/511	8153X6	56

Cod. Covind Covind Ref. Covind Teilnummer	Cod. Originale O.E.M. Ref. OE Nummer	Pag.Cat. Page Cat. Seite
025/512	1613690380	58
025/512	8154PH	58
025/512	815439	58
025/512	8153PE	58
025/512	8153X2	58
025/513	1613693380	60
025/513	8154NF	60
025/513	815466	60
025/513	8153PR	60
025/513	8153Y0	60
025/514	1613689180	62
025/514	8154KR	62
025/514	815427	62
025/514	8153NP	62
025/514	8153W1	62
025/515	1613692480	64
025/515	8154LW	64
025/515	815456	64
025/515	8153PH	64
025/515	8153X4	64
025/516	1613689380	44
025/516	8154KT	44
025/516	815429	44
025/516	8153NR	44
025/516	8153W2	44
025/517	1613693280	46
025/517	8154NE	46

* OEM R1800_COVIND R1200 | OEM R400_COVIND R300 (view legenda)

COVIND.OEM

TABELLE COMPARATIVE CROSS REFERENCE KORRESPONDENZTABELLE

Cod. Covind Covind Ref. Covind Teilnummer	Cod. Originale O.E.M. Ref. OE Nummer	Pag.Cat. Page Cat. Seite
025/517	815464	46
025/517	8153PQ	46
025/517	8153X9	46
025/518	1613689080	48
025/518	8154KQ	48
025/518	815477	48
025/518	8153NN	48
025/518	8153W0	48
025/519	1613692680	50
025/519	8154LY	50
025/519	815458	50
025/519	8153PK	50
025/520	1613690580	52
025/520	8154KY	52
025/520	815441	52
025/520	8153PY	52
025/520	8153S2	52
025/521	1613693780	66
025/521	8154NK	66
025/521	815469	66
025/521	8153PW	66
025/521	8153Y4	66
025/550	8151LH	25, 37, 49, 53, 63
025/551	8151LG	27, 39, 65, 67
025/552	8151LN	25, 37, 49, 53, 63
025/553	8151LL	27, 39, 65, 67
025/555	8151LK	29, 33, 41, 45, 55, 59

Cod. Covind Covind Ref. Covind Teilnummer	Cod. Originale O.E.M. Ref. OE Nummer	Pag.Cat. Page Cat. Seite
025/556	8151LI	31, 35, 43, 47, 51, 57, 61
025/557	8151LQ	29, 33, 41, 45, 55, 59
025/558	8151LP	31, 35, 43, 47, 51, 57, 61
025/560	6325H1	25, 29, 53
025/561	6325H0	27, 31
025/562	6325H4	33, 37, 41, 45, 49, 55, 59, 63
025/563	6325H3	35, 39, 43, 47, 51, 57, 61, 65, 67
DAF		
CF0/500	1952146	6
CF0/500	1813005	6
CF0/501	1952141	8
CF0/501	1808561	8
CF0/502	1818353	7
CF0/502	1788487	7
CF0/502	1788976	7
CF0/503	1812859	9
CF0/503	1788972	9
LF0/500	1704604	2, 214, 246
LF0/500	1700306	2, 214, 246
LF0/501	1700303	4, 216, 248
LF0/502	1704605	18, 226, 258
LF0/502	1700269	18, 226, 258
LF0/503	1700265	20, 228, 260
LF0/504	1736865	3, 19, 215, 227, 247, 259
LF0/505	1736879	5, 21, 217, 229, 249, 261

Cod. Covind Covind Ref. Covind Teilnummer	Cod. Originale O.E.M. Ref. OE Nummer	Pag.Cat. Page Cat. Seite
LF0/506	1736884	3, 5, 19, 21, 215, 217, 227, 229, 247, 249, 259, 261
LF0/507	1736883	3, 5, 19, 21, 215, 217, 227, 229, 247, 249, 259, 261
LF0/508	1736953	19, 227, 259
LF0/509	1736954	21, 229, 261
LF0/510	1781228	2, 18, 214, 226, 246, 258
LF0/511	1781227	4, 20, 216, 228, 248, 260
LF0/512	1735520	2, 18, 214, 226, 246, 258
LF0/513	1735519	4, 20, 216, 228, 248, 260
PRM/504	1737933	3, 5, 19, 21, 215, 217, 219, 221, 223, 225, 227, 229, 247, 249, 259, 261
PRM/508	1733893	3, 215, 219, 223, 247
PRM/509	1733892	5, 217, 221, 225, 249
PRM/512	1736923	3, 19, 215, 219, 223, 227, 247, 259
PRM/512	1409581	3, 19, 215, 219, 223, 227, 247, 259
PRM/513	1736924	5, 21, 217, 221, 225, 229, 249, 261
PRM/513	1409576	5, 21, 217, 221, 225, 229, 249, 261
PRM/522	-	3, 19, 215, 219, 223, 227, 247, 259

Cod. Covind	Cod. Originale	Pag.Cat.
Covind Ref.	O.E.M. Ref.	Page Cat.
Covind Teilnummer	OE Nummer	Seite
PRM/523	-	5, 21, 217, 221, 225, 229, 249, 261
XF0/502	-	14
XF0/503	1610263	16
XF0/503	1397137	16
XF0/504	1610190	* 15, 17
XF0/504	1425109	* 15, 17
XF0/505	1610182	15
XF0/505	1425111	* 15
XF0/505	1610191	* 15
XF0/507	1425113	15, 17
XF0/508	1425114	15
XF0/512	1425118	15
XF0/513	1425116	17
XF0/524	1610189	14
XF0/524	1425108	* 14
XF0/524	1610187	* 14
XF0/524	1670877	* 14
XF0/525	1610184	* 14, 16
XF0/525	1425105	* 14, 16
XF5/500	-	10
XF5/501	-	12
XF5/502	1685330	7, 9, 11, 13
XF5/503	1685331	7, 9, 11, 13
XF5/505	1644326	7, 9, 11, 13
XF5/505	1659249	7, 9, 11, 13
XF5/506	1644325	7, 9, 11, 13

Cod. Covind	Cod. Originale	Pag.Cat.
Covind Ref.	O.E.M. Ref.	Page Cat.
Covind Teilnummer	OE Nummer	Seite
XF5/506	1659248	7, 9, 11, 13
XF5/507	1817860	6, 8, 10, 12
XF5/507	1689347	6, 8, 10, 12
XF5/509	1812862	6, 8, 10, 12
XF5/509	1689348	6, 8, 10, 12
XF5/512	1644323	7, 11
XF5/513	1644324	9, 13
FIAT		
025/500	735620706	24
025/500	735517038	24
025/500	735480884	24
025/500	735424394	24
025/501	735620745	26
025/501	735517070	26
025/501	735480931	26
025/501	735424420	26
025/502	735620709	28
025/502	735517041	28
025/502	735480887	28
025/502	735424397	28
025/503	735620748	30
025/503	735517073	30
025/503	735480934	30
025/503	735424423	30
025/504	735620712	32
025/504	735517044	32
025/504	735480890	32

Cod. Covind	Cod. Originale	Pag.Cat.
Covind Ref.	O.E.M. Ref.	Page Cat.
Covind Teilnummer	OE Nummer	Seite
025/504	735440391	32
025/504	735424400	32
025/505	735661832	34
025/505	735620699	34
025/505	735517079	34
025/505	735480940	34
025/505	735440423	34
025/506	735620732	36
025/506	735517067	36
025/506	735480915	36
025/506	735440385	36
025/507	735620755	38
025/507	735517083	38
025/507	735480944	38
025/507	735440427	38
025/507	735424438	38
025/508	735620700	40
025/508	735517068	40
025/508	735480916	40
025/508	735440388	40
025/509	735675485	42
025/509	735620754	42
025/509	735517082	42
025/509	735480943	42
025/509	735440426	42
025/510	735620711	54
025/510	735517043	54

* OEM R1800_COVIND R1200 | OEM R400_COVIND R300 (view legenda)

Cod. Covind Covind Ref. Covind Teilnummer	Cod. Originale O.E.M. Ref. OE Nummer	Pag.Cat. Page Cat. Seite
025/510	735480889	54
025/510	735440390	54
025/510	735424399	54
025/511	735620750	56
025/511	735517075	56
025/511	735480936	56
025/511	735424425	56
025/511	735440419	56
025/512	735620718	58
025/512	735517052	58
025/512	735501134	58
025/512	735424406	58
025/512	735440399	58
025/512	735480898	58
025/513	735620753	60
025/513	735517081	60
025/513	735480942	60
025/513	735424433	60
025/513	735440425	60
025/514	735620708	62
025/514	735517040	62
025/514	735480886	62
025/514	735424396	62
025/514	735440387	62
025/515	735620747	64
025/515	735517072	64
025/515	735480933	64

Cod. Covind Covind Ref. Covind Teilnummer	Cod. Originale O.E.M. Ref. OE Nummer	Pag.Cat. Page Cat. Seite
025/515	735424422	64
025/515	735440416	64
025/516	735620710	44
025/516	735517042	44
025/516	735480888	44
025/516	735440389	44
025/516	735424398	44
025/517	735620752	46
025/517	735517080	46
025/517	735480941	46
025/517	735440424	46
025/517	735424432	46
025/518	735620707	48
025/518	735517039	48
025/518	735480885	48
025/518	735440386	48
025/518	735424395	48
025/519	735620749	50
025/519	735517074	50
025/519	735480935	50
025/519	735440418	50
025/520	735620720	52
025/520	735517054	52
025/520	735424408	52
025/520	735480900	52
025/520	735440401	52
025/521	735620757	66

Cod. Covind Covind Ref. Covind Teilnummer	Cod. Originale O.E.M. Ref. OE Nummer	Pag.Cat. Page Cat. Seite
025/521	735517085	66
025/521	735480946	66
025/521	735424440	66
025/521	735440429	66
025/550	71748245	25, 37, 49, 53, 63
025/551	71748244	27, 39, 65, 67
025/552	71748249	25, 37, 49, 53, 63
025/553	71748248	27, 39, 65, 67
025/555	71748247	29, 33, 41, 45, 55, 59
025/556	71748246	31, 35, 43, 47, 51, 57, 61
025/557	71748251	29, 33, 41, 45, 55, 59
025/558	71748250	31, 35, 43, 47, 51, 57, 61
025/560	71748253	25, 29, 53
025/561	71748252	27, 31
025/562	71748255	33, 37, 41, 45, 49, 55, 59, 63
025/563	71748254	35, 39, 43, 47, 51, 57, 61, 65, 67
IVECO		
038/500	93924653	102
038/501	93924654	103
038/502	93928072	128
038/503	93928073	129
038/506	93936843	130
038/507	93936842	131
060/500	99457908	148
060/500	42344326	148

Cod. Covind Covind Ref. Covind Teilnummer	Cod. Originale O.E.M. Ref. OE Nummer	Pag.Cat. Page Cat. Seite
060/502	2997216	149
060/502	99457905	149
060/504	93190977	151
060/505	93190971	153
060/507	98472973	167
060/507	98472937	167
060/507	98472998	167
095/500	5801765364	156
095/500	504150552	156
095/500	504369995	156
095/500	5801341207	156
095/500	5801580263	156
095/501	5801765363	158
095/501	504150551	158
095/501	504369979	158
095/501	5801341206	158
095/501	5801580261	158
095/503	5801765367	160
095/503	5801580275	160
095/505	2997668	141, 143, 145, 147, 157, 159, 161
095/505	504197879	141, 143, 145, 147, 157, 159, 161
095/506	504158977	141, 145, 157
095/507	504158976	143, 147, 159, 161
095/508	5801876636	166
095/508	5802287173	166

Cod. Covind Covind Ref. Covind Teilnummer	Cod. Originale O.E.M. Ref. OE Nummer	Pag.Cat. Page Cat. Seite
095/510	5802322000	162
095/510	504224428	162
095/510	5801806044	162
095/511	5802322008	163
095/511	5801806057	163
095/512	504168244	165
095/520	5801765379	164
095/520	504168236	164
440/508	93193203	155
560/500	5801765196	140
560/500	504150527	140
560/500	504369961	140
560/500	5801334610	140
560/500	5801580202	140
560/501	5801765195	142
560/501	504150526	142
560/501	504369910	142
560/501	5801334614	142
560/501	5801580201	142
560/502	5801765318	144, 145
560/502	504150539	144, 145
560/502	504370055	144, 145
560/502	5801336298	144, 145
560/502	5801580230	144, 145
560/503	5801765315	146
560/503	504150538	146
560/503	504370048	146

Cod. Covind Covind Ref. Covind Teilnummer	Cod. Originale O.E.M. Ref. OE Nummer	Pag.Cat. Page Cat. Seite
560/503	5801336285	146
560/503	5801580228	146
560/504	504158975	141, 145, 157
560/505	504158974	143, 147, 159, 161
560/509	2997667	141, 143, 145, 147, 157, 159, 161
560/509	504159282	141, 143, 145, 147, 157, 159, 161
560/509	504159284	141, 143, 145, 147, 157, 159, 161
560/509	504159286	141, 143, 145, 147, 157, 159, 161
560/509	504197878	141, 143, 145, 147, 157, 159, 161
C39/ 24	500321136	138
C39/502	500325726	104
C39/503	500325725	105
D06/ 16	5801304491	136
D06/ 16	69500478	136
D06/426	3801915	85, 89, 97, 107, 111, 115, 119, 123
D06/427	3801914	87, 91, 93, 95, 99, 101, 109, 113, 117, 121, 125, 127
D06/500	5802031932	84
D06/500	5801367639	84
D06/500	5801755747	84

* OEM R1800_COVIND R1200 | OEM R400_COVIND R300 (view legenda)

COVIND.OEM

TABELLE COMPARATIVE CROSS REFERENCE KORRESPONDENZTABELLE

Cod. Covind Covind Ref. Covind Teilnummer	Cod. Originale O.E.M. Ref. OE Nummer	Pag.Cat. Page Cat. Seite
D06/500	3800414	84
D06/501	5802031837	86
D06/501	5801367606	86
D06/501	5801755695	86
D06/501	3800401	86
D06/502	5802032046	118
D06/502	5801367569	118
D06/502	5801736697	118
D06/502	3800425	118
D06/503	5802032049	120
D06/503	5801367573	120
D06/503	5801736702	120
D06/503	3800429	120
D06/504	5802031936	88
D06/504	5801367641	88
D06/504	5801755754	88
D06/504	3800416	88
D06/505	5802031928	90
D06/507	5802031845	92
D06/507	5801755713	92
D06/507	5801367611	92
D06/507	3800404	92
D06/509	5802031841	94
D06/509	5801367610	94
D06/509	5801755712	94
D06/509	3800403	94
D06/510	5802032043	122

Cod. Covind Covind Ref. Covind Teilnummer	Cod. Originale O.E.M. Ref. OE Nummer	Pag.Cat. Page Cat. Seite
D06/510	5801367567	122
D06/510	5801736704	122
D06/510	3800423	122
D06/511	5802032045	124
D06/511	5801367571	124
D06/511	5801736705	124
D06/511	3800427	124
D06/513	5802032040	126
D06/513	5801736695	126
D06/513	5801367570	126
D06/513	3800426	126
D06/516	5802031849	96
D06/516	5801755722	96
D06/516	5801367618	96
D06/516	3800406	96
D06/517	5802031923	98
D06/517	5801367625	98
D06/517	5801755740	98
D06/517	3800409	98
D06/519	5802031838	100
D06/519	5801367608	100
D06/519	5801755709	100
D06/519	3800402	100
D06/550	3801927	85, 89, 97, 107, 111, 115, 119, 123
D06/551	3801926	87, 91, 93, 95, 99, 101, 109, 113, 117, 121, 125,

Cod. Covind Covind Ref. Covind Teilnummer	Cod. Originale O.E.M. Ref. OE Nummer	Pag.Cat. Page Cat. Seite
		127
D06/552	3801929	85, 89, 97, 107, 111, 115, 119, 123
D06/553	3801928	87, 91, 93, 95, 99, 101, 109, 113, 117, 121, 125, 127
D06/554	3801911	85, 89, 97, 119, 123
D06/555	3801910	87, 91, 93, 95, 99, 101, 121, 125, 127
D06/556	3800501	85, 89
D06/557	3800500	99
D06/559	3800503	121, 125, 127
D06/566	3800471	97
D06/567	3800472	87, 91, 93, 95, 101
D12/ 15	5801484207	134
D12/ 15	5801399646	134
D12/558	3800473	119, 123
D14/ 15	5801511735	132
D14/500	5802028037	74
D14/500	5801552553	74
D14/501	5802028036	76
D14/501	5801552552	76
D14/502	5802029773	114
D14/502	5801679489	114
D14/503	5802029774	116
D14/503	5801687143	116
D14/505	5802028039	78

Cod. Covind Covind Ref. Covind Teilnummer	Cod. Originale O.E.M. Ref. OE Nummer	Pag.Cat. Page Cat. Seite
D14/505	5801552556	78
D14/508	5802495901	80
D14/508	5802028034	80
D14/508	5801552547	80
D14/509	5802495902	82
D14/509	5802028033	82
D14/509	5801552546	82
D14/530	5801823334	71, 75, 81
D14/531	5801823572	73, 77, 79, 83
D14/550	5801823306	71, 75, 81
D14/551	5801823992	73, 77, 79, 83
D14/552	5801823346	71, 75, 81
D14/553	5801823557	73, 77, 79, 83
D14/554	5801823377	75, 81
D14/555	5801823582	77, 79, 83
D16/500	5802495904	70
D16/500	5802029650	70
D16/500	5801552549	70
D16/501	5802495903	72
D16/501	5802029582	72
D16/501	5801552548	72
D16/502	5802029805	106
D16/502	5801687178	106
D16/503	5802029799	108
D16/503	5801681268	108
D16/510	5802029798	110
D16/510	5801679492	110

Cod. Covind Covind Ref. Covind Teilnummer	Cod. Originale O.E.M. Ref. OE Nummer	Pag.Cat. Page Cat. Seite
D16/511	5802029776	112
D16/511	5801679491	112
D16/555	5801822999	109, 113, 117
D16/557	5801822996	109, 113, 117
D16/558	5801822982	107, 111, 115
D16/560	5801822986	111, 115
D16/562	5801823823	71
D16/563	5801823777	73
D16/565	5802495899	71, 81
D16/566	5802495900	73, 83
MAN		
MLX/500	-	170
MLX/501	-	172, 173
MLX/506	81637316560	171
MLX/506	81637316467	171
MLX/507	81637316557	173
MLX/507	81637316431	173
TGS/500	81637306762	174
TGS/500	81637306550	174
TGS/501	81637306755	176
TGS/501	81637306549	176
TGS/502	81637336071	175, 177, 179, 181
TGS/504	81637336072	175, 179
TGS/505	81637336073	177, 181
TGX/502	81637306765	178
TGX/502	81637306561	178
TGX/503	81637306756	180

Cod. Covind Covind Ref. Covind Teilnummer	Cod. Originale O.E.M. Ref. OE Nummer	Pag.Cat. Page Cat. Seite
TGX/503	81637306560	180
XXL/500	81637336049	171, 173, 183, 185
XXL/500	81637336034 *	171, 173, 183, 185
XXL/500	81637336053 *	171, 173, 183, 185
XXL/501	81637336057	171, 173, 183, 185
XXL/501	81637336037 *	171, 173, 183, 185
XXL/502	81637320062	171, 183
XXL/502	81637320056	171, 183
XXL/502	81637320066	171, 183
XXL/503	81637320061	173, 185
XXL/503	81637320057	173, 185
XXL/503	81637320065	173, 185
XXL/506	81637320060	171, 183
XXL/506	81637320055	171, 183
XXL/506	81637320064	171, 183
XXL/507	81637320059	173, 185
XXL/507	81637320054	173, 185
XXL/507	81637320063	173, 185
XXL/508	-	182
XXL/509	-	184
XXL/512	81637316618	183
XXL/512	81637316614	183
XXL/513	81637316617	185
XXL/513	81637316613	185
XXL/522	81637306481	170, 182
XXL/522	81637306432 *	170, 182
XXL/523	81637306480	172, 184

* OEM R1800_COVIND R1200 | OEM R400_COVIND R300 (view legenda)

COVIND.OEM

TABELLE COMPARATIVE CROSS REFERENCE KORRESPONDENZTABELLE

Cod. Covind Covind Ref. Covind Teilnummer	Cod. Originale O.E.M. Ref. OE Nummer	Pag.Cat. Page Cat. Seite
XXL/523	81637306430 *	172, 184
XXL/524	81637306513	170, 182
XXL/524	81637306444 *	170, 182
XXL/525	81637306512	172, 184
XXL/525	81637306443 *	172, 184
MERCEDES-BENZ		
940/510	9408107516	208
940/511	9408107316	209
941/500	-	204
941/501	-	206
941/502	0028110433	197, 199, 205, 207
941/503	0018116033	189, 191, 197, 199, 205
941/504	0008111307	189, 191, 197, 199, 205, 207
941/506	0018104514	205
941/507	0018104414	207
941/508	0018109216	188, 190, 196, 198, 204
941/509	0018109116	196, 198, 204, 206
941/514	9418110007	197, 199, 205, 207
943/492	0028113833	201
943/493	0028113733	203
943/496	0028113433	201
943/497	0028113333	203
943/500	-	196
943/501	-	198
943/502	9438106016	200
943/503	9438105816	202

Cod. Covind Covind Ref. Covind Teilnummer	Cod. Originale O.E.M. Ref. OE Nummer	Pag.Cat. Page Cat. Seite
943/504	9438110407	201
943/505	9438110307	203
943/506	0028100914	197
943/507	0028100814	199
943/508	0028102516	201
943/509	0028102416	203
943/513	9438110107	201, 203
943/514	9438110207	201, 203
943/522	9438105116	210
943/526	0028103314	201
943/527	0028103214	203
973/500	-	188
973/501	-	190
973/502	-	192
973/503	-	194
973/504	00018113433 *	188, 189, 190, 191
973/505	0018119933	192, 193, 194, 195
973/506	0028110033	192, 193, 194, 195
973/507	0008112007	193, 195
973/508	9738100414	189
973/509	9738100314	191
973/510	0028100816	211
973/510	9408102616	211
973/511	0008100379	188, 190
973/512	0018109814	193
973/513	0018109714	195
973/514	0008110461	189

Cod. Covind Covind Ref. Covind Teilnummer	Cod. Originale O.E.M. Ref. OE Nummer	Pag.Cat. Page Cat. Seite
973/515	0008110361	191
973/516	0008102179	192
973/516	0008101579	192
973/517	0008102079	194
973/517	0008101879	194
973/518	0008102479	192, 194
973/518	0008101679	192, 194
PEUGEOT		
025/500	1613688980	24
025/500	8154KP	24
025/500	8153ZZ	24
025/500	8153Y5	24
025/501	1613692280	26
025/501	8154LT	26
025/501	815422	26
025/501	8153Y7	26
025/502	1613689280	28
025/502	8154KS	28
025/502	815420	28
025/502	8153Y6	28
025/503	1613692580	30
025/503	8154LX	30
025/503	815423	30
025/503	8153Y8	30
025/504	1613689580	32
025/504	8154KW	32
025/504	815431	32

Cod. Covind Covind Ref. Covind Teilnummer	Cod. Originale O.E.M. Ref. OE Nummer	Pag.Cat. Page Cat. Seite
025/504	8153NT	32
025/504	8153W4	32
025/505	1635685380	34
025/505	1613693180	34
025/505	8154NC	34
025/505	815463	34
025/505	8153PP	34
025/506	1613691880	36
025/506	8154LQ	36
025/506	815425	36
025/506	8153NL	36
025/507	1613693580	38
025/507	8154NH	38
025/507	815467	38
025/507	8153PT	38
025/507	8153Y2	38
025/508	1613691980	40
025/508	8154LR	40
025/508	815428	40
025/508	8153NQ	40
025/509	1613693480	42
025/509	8154NG	42
025/509	815465	42
025/509	8153PS	42
025/510	1613689480	54
025/510	8154KV	54
025/510	815430	54

Cod. Covind Covind Ref. Covind Teilnummer	Cod. Originale O.E.M. Ref. OE Nummer	Pag.Cat. Page Cat. Seite
025/510	8153NS	54
025/510	8153W3	54
025/511	1613692780	56
025/511	8154LZ	56
025/511	815459	56
025/511	8153PL	56
025/511	8153X6	56
025/512	1613690380	58
025/512	8154PH	58
025/512	815439	58
025/512	8153PE	58
025/512	8153X2	58
025/513	1613693380	60
025/513	8154NF	60
025/513	815466	60
025/513	8153PR	60
025/513	8153Y0	60
025/514	1613689180	62
025/514	8154KR	62
025/514	815427	62
025/514	8153NP	62
025/514	8153W1	62
025/515	1613692480	64
025/515	8154LW	64
025/515	815456	64
025/515	8153PH	64
025/515	8153X4	64

Cod. Covind Covind Ref. Covind Teilnummer	Cod. Originale O.E.M. Ref. OE Nummer	Pag.Cat. Page Cat. Seite
025/516	1613689380	44
025/516	8154KT	44
025/516	815429	44
025/516	8153NR	44
025/516	8153W2	44
025/517	1613693280	46
025/517	8154NE	46
025/517	815464	46
025/517	8153PQ	46
025/517	8153X9	46
025/518	1613689080	48
025/518	8154KQ	48
025/518	815477	48
025/518	8153NN	48
025/518	8153W0	48
025/519	1613692680	50
025/519	8154LY	50
025/519	815458	50
025/519	8153PK	50
025/520	1613690580	52
025/520	8154KY	52
025/520	815441	52
025/520	8153PY	52
025/520	8153S2	52
025/521	1613693780	66
025/521	8154NK	66
025/521	815469	66

* OEM R1800_COVIND R1200 | OEM R400_COVIND R300 (view legenda)

COVIND.OEM

TABELLE COMPARATIVE CROSS REFERENCE KORRESPONDENZTABELLE

Cod. Covind Covind Ref. Covind Teilnummer	Cod. Originale O.E.M. Ref. OE Nummer	Pag.Cat. Page Cat. Seite
025/521	8153PW	66
025/521	8153Y4	66
025/550	8151LH	25, 37, 49, 53, 63
025/551	8151LG	27, 39, 65, 67
025/552	8151LN	25, 37, 49, 53, 63
025/553	8151LL	27, 39, 65, 67
025/555	8151LK	29, 33, 41, 45, 55, 59
025/556	8151LI	31, 35, 43, 47, 51, 57, 61
025/557	8151LQ	29, 33, 41, 45, 55, 59
025/558	8151LP	31, 35, 43, 47, 51, 57, 61
025/560	6325H1	25, 29, 53
025/561	6325H0	27, 31
025/562	6325H4	33, 37, 41, 45, 49, 55, 59, 63
025/563	6325H3	35, 39, 43, 47, 51, 57, 61, 65, 67
RENAULT		
LF0/500	5010623232	2, 214, 246
LF0/500	7421326527	2, 214, 246
LF0/501	5010623231	4, 216, 248
LF0/502	5010623247	18, 226, 258
LF0/502	7421326526	18, 226, 258
LF0/503	5010623246	20, 228, 260
LF0/504	7420862815	3, 19, 215, 227, 247, 259
LF0/505	7420862810	5, 21, 217, 229, 249, 261
LF0/506	7420862779	3, 5, 19, 21, 215, 217, 227, 229, 247, 249, 259,

Cod. Covind Covind Ref. Covind Teilnummer	Cod. Originale O.E.M. Ref. OE Nummer	Pag.Cat. Page Cat. Seite
		261
LF0/507	7420862800	3, 5, 19, 21, 215, 217, 227, 229, 247, 249, 259, 261
LF0/508	7420903732	19, 227, 259
LF0/509	7420903723	21, 229, 261
LF0/510	-	2, 18, 214, 226, 246, 258
LF0/511		4, 20, 216, 228, 248, 260
LF0/512	-	2, 18, 214, 226, 246, 258
LF0/513	-	4, 20, 216, 228, 248, 260
PRM/500	7421326550	218
PRM/500	5010578504	218
PRM/501	5010578503	220
PRM/502	7420903883	219
PRM/503	7420903882	221
PRM/504	7420862795	3, 5, 19, 21, 215, 217, 219, 221, 223, 225, 227, 229, 247, 249, 259, 261
PRM/505	7420903880	219, 221
PRM/506	7420903746	219, 223
PRM/507	7420903745	221, 225
PRM/508	7420903727	3, 215, 219, 223, 247
PRM/509	7420903722	5, 217, 221, 225, 249
PRM/511	7420903881	223, 225
PRM/512	5010623058	3, 19, 215, 219, 223, 227, 247, 259
PRM/513	5010623057	5, 21, 217, 221, 225, 229,

Cod. Covind Covind Ref. Covind Teilnummer	Cod. Originale O.E.M. Ref. OE Nummer	Pag.Cat. Page Cat. Seite
		249, 261
PRM/522	-	3, 19, 215, 219, 223, 227, 247, 259
PRM/523	-	5, 21, 217, 221, 225, 229, 249, 261
PRM/526	7420903887	223
PRM/527	7420903885	225
PRM/528	5010578506	222
PRM/528	7421326551	222
PRM/529	5010578505	224
PRM/530	-	218
PRM/531	-	220
PRM/532	-	218
PRM/533	-	220
PRM/534	-	222
PRM/535	-	224
PRM/536	-	222
PRM/537	-	224
SCANIA		
144/501	1765985	233, 235, 237, 239, 241, 243
144/502	1767265	235, 237, 241, 243
144/503	-	232
144/505	2425815	238
144/505	1723518	238
144/506	2425816	240
144/506	1723519	240

Cod. Covind Covind Ref. Covind Teilnummer	Cod. Originale O.E.M. Ref. OE Nummer	Pag.Cat. Page Cat. Seite
144/507	-	242
144/508	-	234
144/509	-	236
144/510	1765808	234, 240
144/510	1732783	* 234, 240
144/511	1765809	236, 242
144/511	1732782	* 236, 242
144/512	1346380	233, 235, 237, 239, 241, 243
VOLVO		
0FH/506	20854564	255, 257
0FH/506	3092854	255, 257
0FH/507	21203311	255, 257
0FH/508	-	254
0FH/509	-	256
0FH/512	3091751	255
0FH/513	3091750	257
2FH/500	-	250
2FH/501	-	252
2FH/502	20746401	251, 253
2FH/502	20360810	251, 253
2FH/503	21320404	251, 253, 263, 265
2FH/503	20589788	251, 253, 263, 265
2FH/504	21320300	251, 253
2FH/504	20567685	251, 253
2FH/504	20455995	251, 253
2FH/508	20360811	251, 253

Cod. Covind Covind Ref. Covind Teilnummer	Cod. Originale O.E.M. Ref. OE Nummer	Pag.Cat. Page Cat. Seite
3FH/502	-	250
3FH/503	-	252
3FH/504	22286155	262
3FH/505	22286149	264
3FH/506	-	262
3FH/507	-	264
3FH/508	20841436	263, 265
3FH/509	21320365	263, 265
3FH/509	20589798	263, 265
3FH/509	21070768	263, 265
3FH/511	21169974	263, 265
3FH/511	20746402	263, 265
LF0/500	21326527	2, 214, 246
LF0/500	20743983	2, 214, 246
LF0/501	20707881	4, 216, 248
LF0/502	21475603	18, 226, 258
LF0/502	20708303	18, 226, 258
LF0/503	20707874	20, 228, 260
LF0/504	20862815	3, 19, 215, 227, 247, 259
LF0/505	20862810	5, 21, 217, 229, 249, 261
LF0/506	20862779	3, 5, 19, 21, 215, 217, 227, 229, 247, 249, 259, 261
LF0/507	20862800	3, 5, 19, 21, 215, 217, 227, 229, 247, 249, 259, 261
LF0/508	20903732	19, 227, 259

Cod. Covind Covind Ref. Covind Teilnummer	Cod. Originale O.E.M. Ref. OE Nummer	Pag.Cat. Page Cat. Seite
LF0/509	20903723	21, 229, 261
LF0/510	-	2, 18, 214, 226, 246, 258
LF0/511	-	4, 20, 216, 228, 248, 260
LF0/512	-	2, 18, 214, 226, 246, 258
LF0/513	-	4, 20, 216, 228, 248, 260
PRM/504	20862795	3, 5, 19, 21, 215, 217, 219, 221, 223, 225, 227, 229, 247, 249, 259, 261
PRM/508	20903727	3, 215, 219, 223, 247
PRM/509	20903722	5, 217, 221, 225, 249
PRM/512	20708230	3, 19, 215, 219, 223, 227, 247, 259
PRM/513	20708110	5, 21, 217, 221, 225, 229, 249, 261
PRM/522	-	3, 19, 215, 219, 223, 227, 247, 259
PRM/523	-	5, 21, 217, 221, 225, 229, 249, 261

* OEM R1800_COVIND R1200 | OEM R400_COVIND R300 (view legenda)



- IT Progetto specchi retrovisori. Stampo per copertura inferiore del braccio, in ABS
- EN Rear - view mirrors project. Mould for ABS lower arm cover
- DE Rückspiegel-Projekt. Stahlform für ABS untere Armabdeckung



- IT Progetto specchi retrovisori. Stampo per copertura superiore del braccio, in ABS
- EN Rear - view mirrors project. Mould for ABS upper arm cover
- DE Rückspiegel-Projekt. Stahlform für ABS obere Armabdeckung

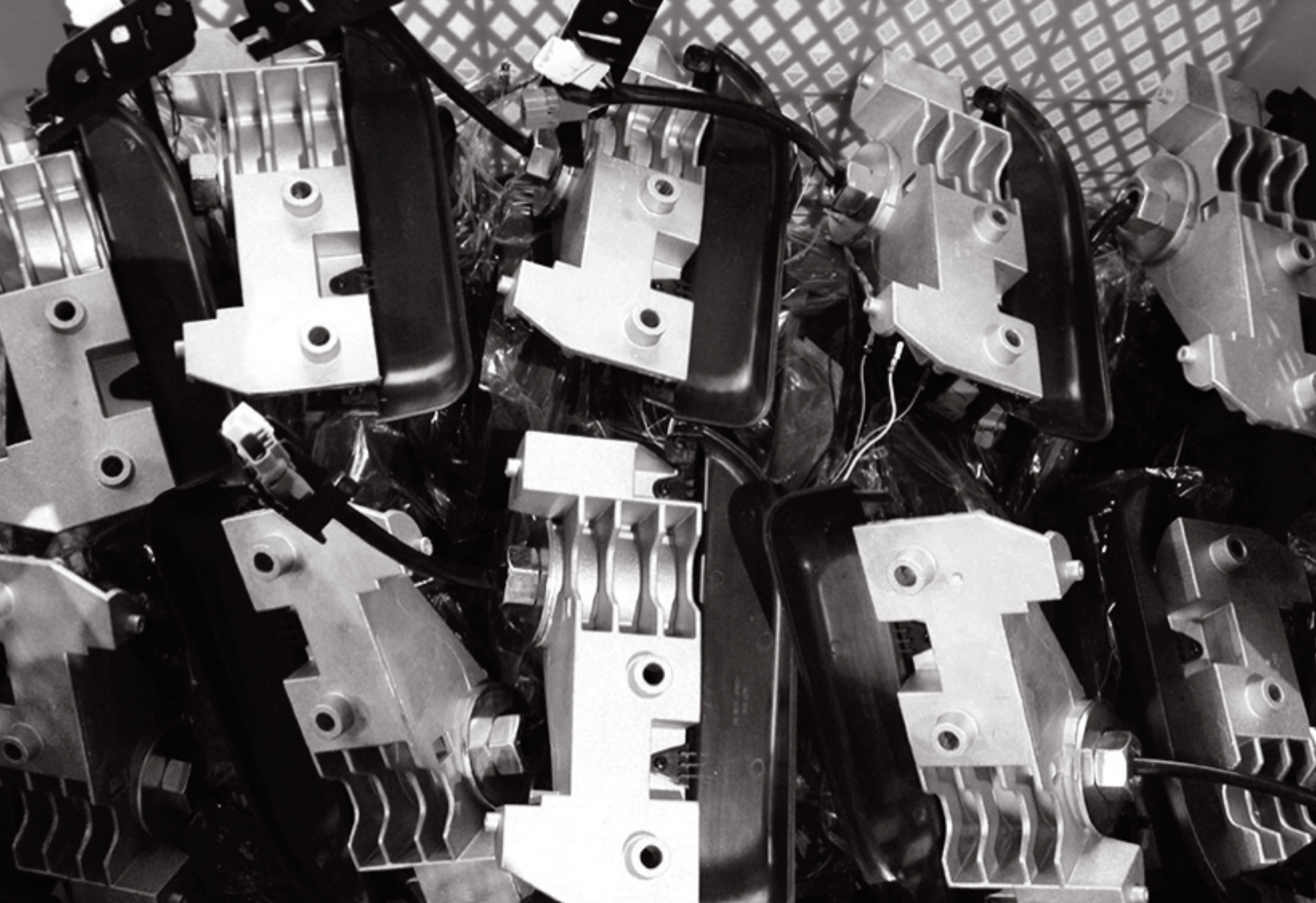

COVIND



suitable to

DAF

1

suitable to

DAF

LF0/500

1704604
(1700306)



II

E4 024104

202x337 mm



IV

E4 024105

200x197 mm

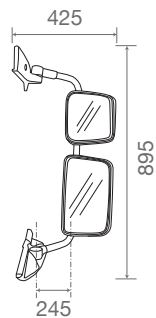

applicabilità:
applicable to:
Verwendbar für

DAF LF0. LF 45 05/2006→
DAF LF0. LF 55 05/2006→
DAF LF6. LF 45 Euro 6
DAF LF6. LF 55 Euro 6

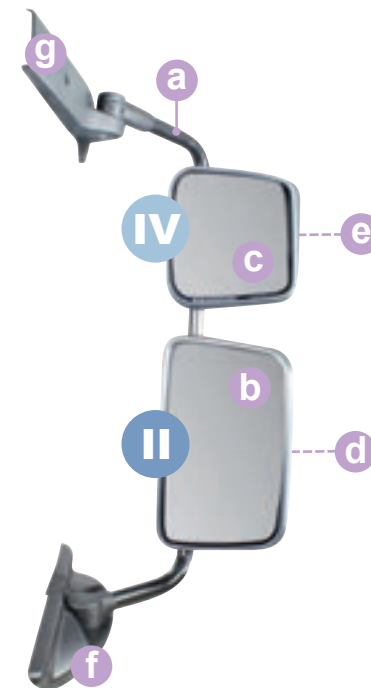

LF0/512

II

1735520



244x370 mm

LF0/510

IV

1781228



235x243 mm

LF0/500



S

M

L

a	PRM/508	1733893			+ g 323x895 mm
b	PRM/504	1737933			E4 024104 202x337 mm
	II				
c	LF0/504	1736865			E4 024105 200x197 mm
	IV				
d	LF0/506	1736884			241x369 mm
	II				
e	LF0/507	1736883			235x241 mm
	IV				
f	PRM/512	1736923 (1409581)			
g	PRM/522	-			

COVIND

DAF

suitable to **DAF**

LF0/501

1700303



II

E4 024104

202x337 mm



IV

E4 024105

200x197 mm

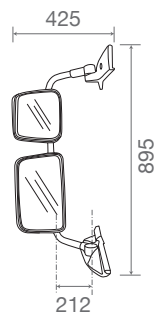

applicabilità:
applicable to:
Verwendbar für

DAF LF0. LF 45 05/2006→
DAF LF0. LF 55 05/2006→
DAF LF6. LF 45 Euro 6
DAF LF6. LF 55 Euro 6

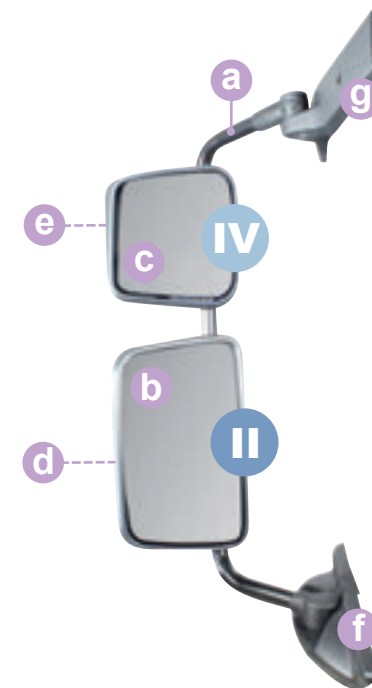

LF0/513

II

1735519



241x370 mm

LF0/511

IV

1781227



234x245 mm

LF0/501



S

M

L

a PRM/509 1733892



+ **g**
323x895 mm

b PRM/504 1737933



E4 024104
202x337 mm

II

c LF0/505 1736879



E4 024105
200x197 mm

IV

d LF0/506 1736884



241x369 mm

II

e LF0/507 1736883



235x241 mm

IV

f PRM/513 1736924
(1409576)



g PRM/523 -



suitable to **DAF**

CF0/500

1952146
(1813005)



II

E4 024094

177x363 mm



IV

E4 024095

207x161 mm

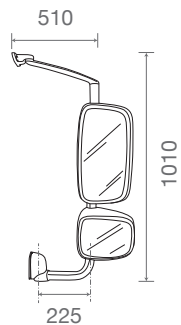

applicabilità:
applicable to:
Verwendbar für

DAF CF0. CF 65-75-85 07/2009→2011
DAF CF6. CF Euro 6

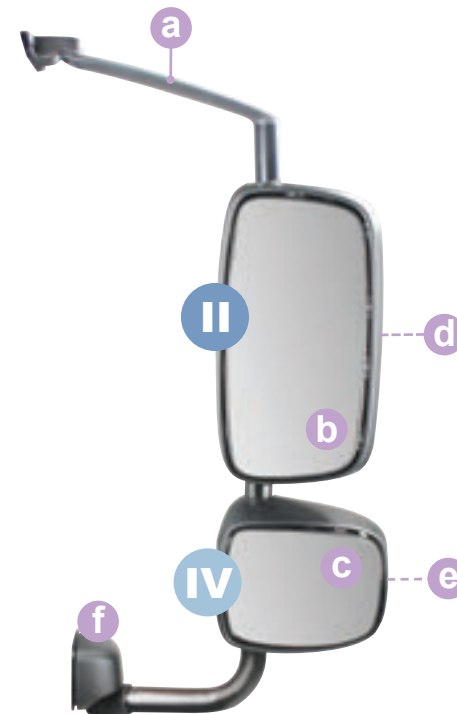

XF5/509

1812862
(1689348)



224x412 mm

II

XF5/507

1817860
(1689347)



242x222 mm

IV

CF0/500



S

M

L

<p>a CF0/502</p>	<p>1818353 (1788487) (1788976)</p>			<p>+ f 385x1010 mm</p>
<p>b XF5/502 II</p>	<p>1685330</p>			<p>E4 024094 177x363 mm</p>
<p>c XF5/503 IV</p>	<p>1685331</p>			<p>E4 024095 207x161 mm</p>
<p>d XF5/506 II</p>	<p>1644325 (1659248)</p>			<p>223x410 mm</p>
<p>e XF5/505 IV</p>	<p>1644326 (1659249)</p>			<p>242x218 mm</p>
<p>f XF5/512</p>	<p>1644323</p>			

suitable to **DAF**

CF0/501

1952141
(1808561)



II

E4 024094

177x363 mm



IV

E4 024095

207x161 mm

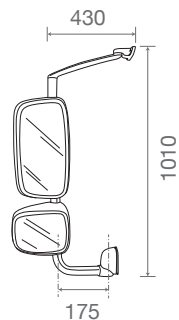

applicabilità:
applicable to:
Verwendbar für

DAF CF0. CF 65-75-85 07/2009→2011
DAF CF6. CF Euro 6

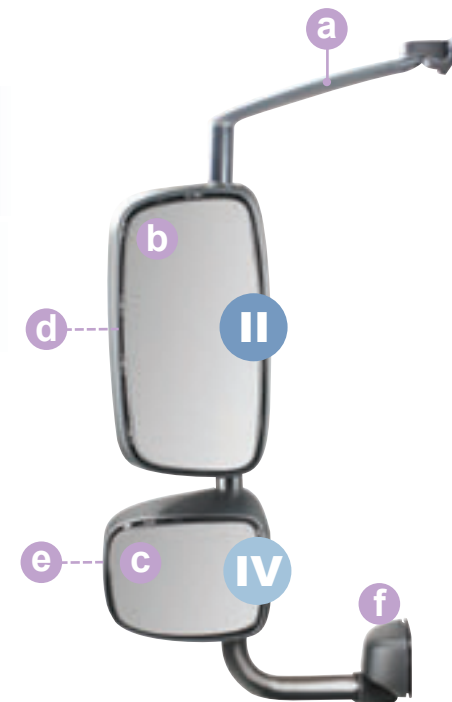

XF5/509

1812862
(1689348)



224x412 mm

XF5/507

1817860
(1689347)



242x222 mm

CF0/501



S

M

L

a CF0/503

1812859
(1788972)



+ **f**
385x1010 mm

b XF5/502

1685330



E4 024094
177x363 mm

II

c XF5/503

1685331



E4 024095
207x161 mm

IV

d XF5/506

1644325
(1659248)



223x410 mm

II

e XF5/505

1644326
(1659249)



242x218 mm

IV

f XF5/513

1644324



suitable to **DAF**

XF5/500

II (E4) 024094
177x363 mm

IV (E4) 024095
207x161 mm

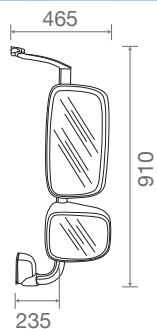

applicabilità:
applicable to:
Verwendbar für

DAF XF2. XF95 07/2009→
DAF XF5. XF105→2011

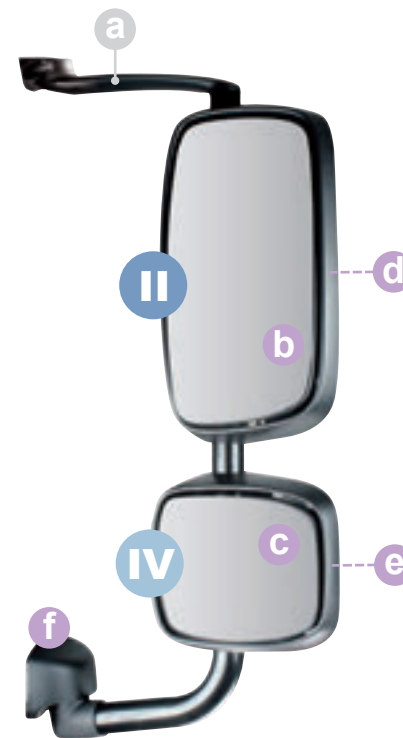

XF5/509

II

1812862
(1689348)



224x412 mm

XF5/507

IV

1817860
(1689347)



242x222 mm

XF5/500



S

M

L

a

b

XF5/502

1685330



E4 024094
177x363 mm

II

c

XF5/503

1685331



E4 024095
207x161 mm

IV

d

XF5/506

1644325
(1659248)



223x410 mm

II

e

XF5/505

1644326
(1659249)



242x218 mm

IV

f

XF5/512

1644323



suitable to **DAF**

XF5/501

II (E4) 024094
177x363 mm

IV (E4) 024095
207x161 mm



applicabilità:
applicable to:
verwendbar für

DAF XF2. XF95 07/2009→
DAF XF5. XF105→2011

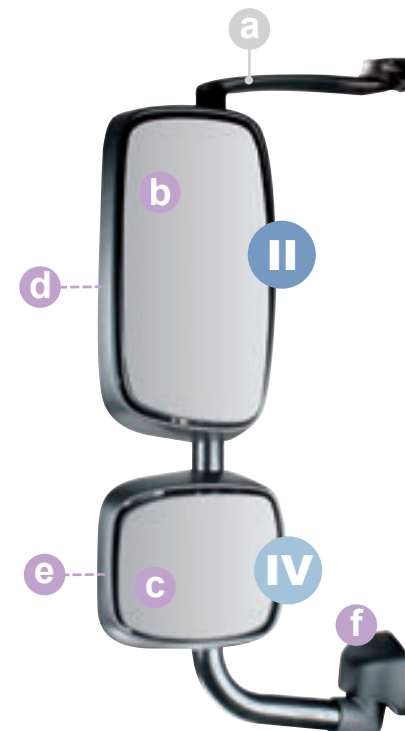
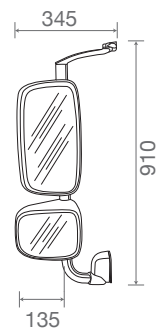

XF5/509

II

1812862
(1689348)



224x412 mm

XF5/507

IV

1817860
(1689347)



242x222 mm

XF5/501



S

M

L

a

-

-

b

XF5/502

1685330



E4 024094
177x363 mm

II

c

XF5/503

1685331



E4 024095
207x161 mm

IV

d

XF5/506

1644325
(1659248)



223x410 mm

II

e

XF5/505

1644326
(1659249)



242x218 mm

IV

f

XF5/513

1644324



suitable to **DAF**

XF0/502

II (E4) 024096
189x368 mm

IV (E4) 024097
204x195 mm

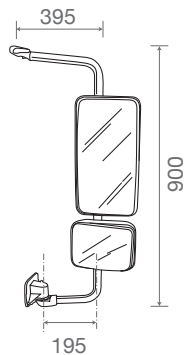

applicabilità:
applicable to:
Verwendbar für

DAF XF0. 95XF 2000→
DAF XF2. XF95 →2006

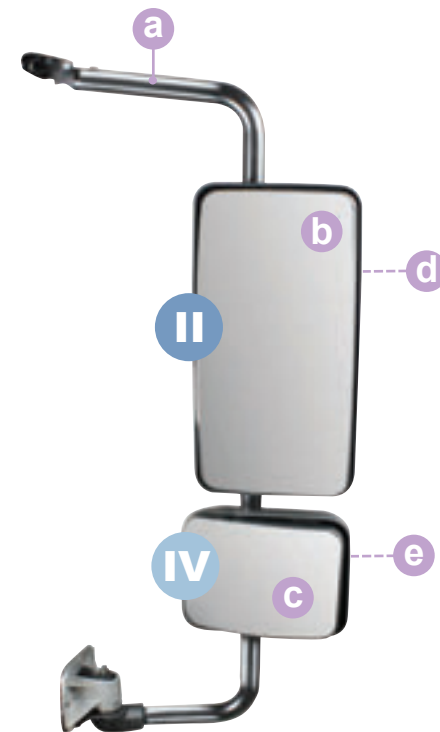

XF0/525
II

1610184*
(1425105)*



203x380 mm

XF0/524
IV

1610189



216x167 mm

XF0/502



S

M

L

a XF0/512

1425118



280x900 mm

b XF0/504

1610190*
(1425109)*



E4 024096
189x368 mm

II

c XF0/505

1610182



E4 024097
204x195 mm

IV

d XF0/507

1425113



187x367 mm

II

e XF0/508

1425114



202x151 mm

IV

* OEM R1800_COVIND R1200 // OEM R400_COVIND R300 (view legenda)

suitable to **DAF**

XF0/503

1610263
(1397137)



E4 024096

189x368 mm

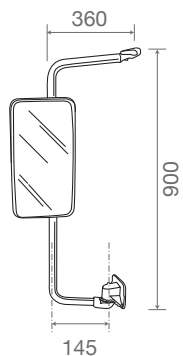

applicabilità:
applicable to:
Verwendbar für

DAF XF0. 95XF 2000→
DAF XF2. XF95 →2006

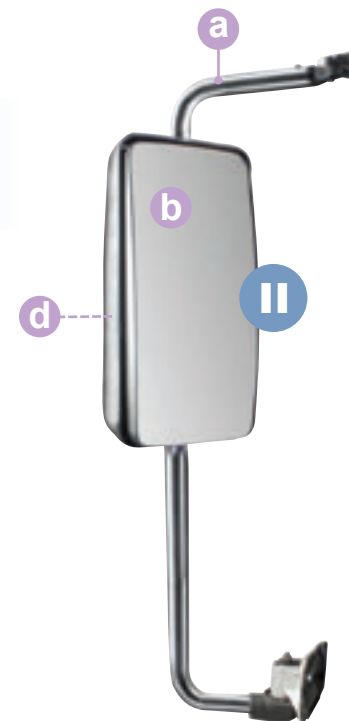

XF0/525

1610184*
(1425105)*



203x380 mm



XF0/503



S
M
L

a XF0/513

1425116



235x900mm

b XF0/504

1610190*
(1425109)*

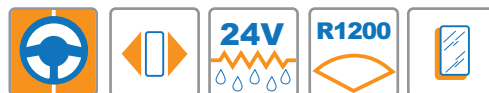

E4 024096

189x368 mm

d XF0/507

1425113



187x367mm

* OEM R1800_COVIND R1200 // OEM R400_COVIND R300 (view legenda)

suitable to **DAF**

LF0/502

1704605
(1700269)



II (E4) 024104
202x337 mm



IV (E4) 024105
200x197 mm

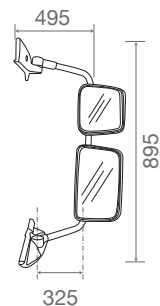

applicabilità:
applicable to:
Verwendbar für

DAF LF0. LF 45 05/2006→
DAF LF0. LF 55 05/2006→
DAF LF6. LF 45 Euro 6
DAF LF6. LF 55 Euro 6

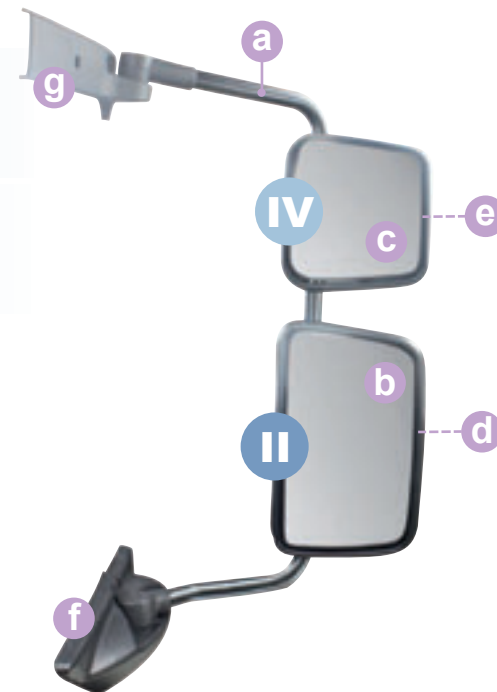

LF0/512
II

1735520



244x370 mm

LF0/510
IV

1781228



235x243 mm

LF0/502



S
M
L

<p>a LF0/508</p>	<p>1736953</p>			<p>+ g 323x895 mm</p>
<p>b PRM/504 II</p>	<p>1737933</p>			<p>E4 024104 202x337 mm</p>
<p>c LF0/504 IV</p>	<p>1736865</p>			<p>E4 024105 200x197 mm</p>
<p>d LF0/506 II</p>	<p>1736884</p>			<p>241x369 mm</p>
<p>e LF0/507 IV</p>	<p>1736883</p>			<p>235x241 mm</p>
<p>f PRM/512</p>	<p>1736923 (1409581)</p>			
<p>g PRM/522</p>	<p>-</p>			

suitable to **DAF**

LF0/503

1700265



II

(E4) 024104

202x337 mm



IV

(E4) 024105

200x197 mm

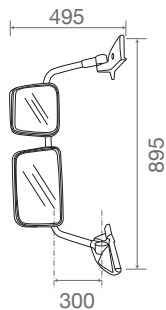

applicabilità:
applicable to:
Verwendbar für

DAF LF0. LF 45 05/2006→
DAF LF0. LF 55 05/2006→
DAF LF6. LF 45 Euro 6
DAF LF6. LF 55 Euro 6

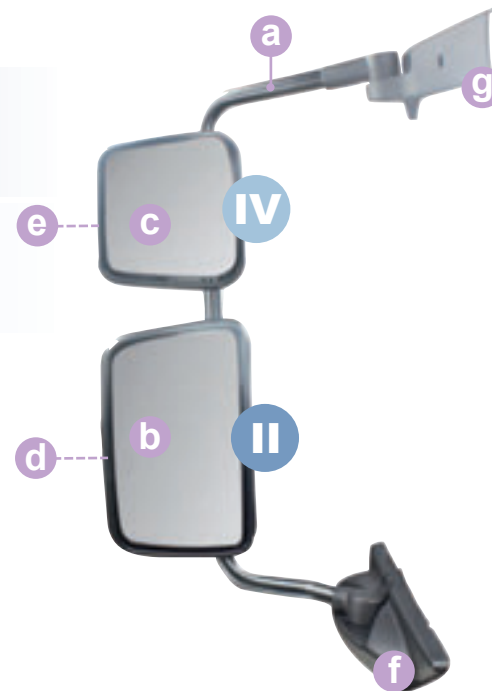

LF0/513

1735519



241x370 mm

II

LF0/511

1781227



234x245 mm

IV

LF0/503



S
M
L

a LF0/509 1736954



+ **g**
323x895 mm

b PRM/504 1737933



E4 024104
202x337 mm

II

c LF0/505 1736879



E4 024105
200x197 mm

IV

d LF0/506 1736884



241x369 mm

II

e LF0/507 1736883



235x241 mm

IV

f PRM/513 1736924
(1409576)



g PRM/523 -



COVIND

DAF



- IT Progetto specchi retrovisori. Stampo per supporto superiore del braccio, in ABS
EN Rear - view mirrors project. Mould for ABS bracket
DE Rückspiegel-Projekt. Stahlform für ABS Abdeckung des oberen Spiegelhalters

COVID

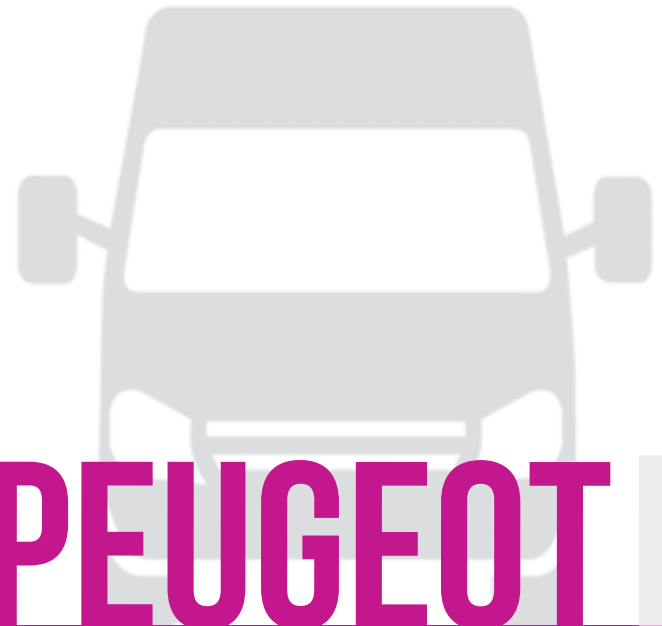

FIAT . CITROËN . PEUGEOT

suitable to FIAT.CITROËN.PEUGEOT

025/500

735620706

(735517038)

(735480884)

(735424394)

1613688980

(8154KP)

(8153ZZ)

(8153Y5)



E3 011030

188x267 mm



E3 011030

185x78 mm

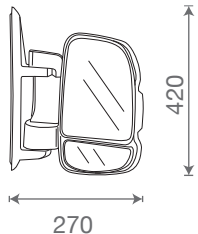

applicabilità:
applicable to:
Verwendbar für

FIAT 025. Ducato 2006→2013
CITROËN 025. Jumper 2006→2013
PEUGEOT 025. Boxer 2006→2013



025/500



S

M

L

b 025/550

71748245
8151LH



E3 011030

188x267 mm



c 025/552

71748249
8151LN



E3 011030

185x78 mm



i 025/560

71748253
6325H1



81,3x129 mm

COVID

FIAT
CITROËN
PEUGEOT

suitable to FIAT.CITROËN.PEUGEOT

025/501

735620745

(735517070)

(735480931)

(735424420)

1613692280

(8154LT)

(815422)

(8153Y7)



E3 011029

188x267 mm



E3 011029

185x78 mm

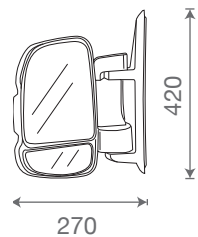

applicabilità:
applicable to:
Verwendbar für

FIAT 025. Ducato 2006

FIAT 027. Ducato 2014

CITROËN 025. Jumper 2006

CITROËN 027. Jumper 2014

PEUGEOT 025. Boxer 2006

PEUGEOT 027. Boxer 2014



025/501



b 025/551
II

71748244
8151LG



E3 011029
188x267 mm

c 025/553
III

71748248
8151LL



E3 011029
185x78 mm

i 025/561

71748252
6325H0



81,3x129 mm

COVID

FIAT
CITROËN
PEUGEOT

suitable to FIAT.CITROËN.PEUGEOT

025/502

735620709
(735517041)
(735480887)
(735424397)



1613689280
(8154KS)
(815420)
(8153Y6)

II (E3) 011030
188x267 mm

III (E3) 011030
185x78 mm

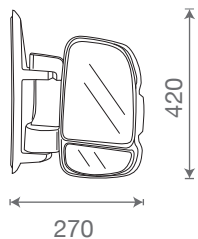

applicabilità:
applicable to:
Verwendbar für

FIAT 025. Ducato 2006→
CITROËN 025. Jumper 2006→
PEUGEOT 025. Boxer 2006→



025/502



S

M

L

b 025/555



71748247
8151LK



E3 011030
188x267 mm

c 025/557



71748251
8151LQ



E3 011030
185x78 mm

i 025/560

71748253
6325H1



81,3x129 mm

COVID

FIAT
CITROËN
PEUGEOT

FIAT.CITROËN.PEUGEOT

025/503

735620748
 (735517073)
 (735480934)
 (735424423)
 1613692580



II (E3) 011029
 188x267 mm

(8154LX)
 (815423)
 (8153Y8)

III (E3) 011029
 185x78 mm

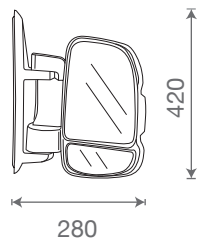

applicabilità:
 applicable to:
 Verwendbar für

FIAT 025. Ducato 2006
 FIAT 027. Ducato 2014
 CITROËN 025. Jumper 2006
 CITROËN 027. Jumper 2014
 PEUGEOT 025. Boxer 2006
 PEUGEOT 027. Boxer 2014



025/503



S
M
L

b 025/556

71748246
8151LI



E3 011029
188x267 mm



c 025/558

71748250
8151LP



E3 011029
185x78 mm



i 025/561

71748252
6325H0



81,3x129 mm

COVID

FIAT
CITROËN
PEUGEOT

suitable to FIAT.CITROËN.PEUGEOT

025/504

735620712
 (735517044)
 (735480890)
 (735440391)
 (735424400)

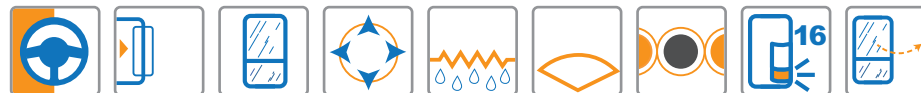

(E3) 011030

188x267 mm

1613689580
 (8154KW)
 (815431)
 (8153NT)
 (8153W4)



(E3) 011030

185x78 mm

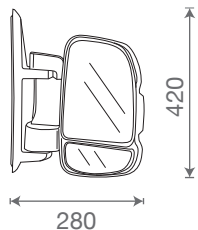

applicabilità:
 applicable to:
 Verwendbar für

FIAT 025. Ducato 2006
 FIAT 027. Ducato 2014
 CITROËN 025. Jumper 2006
 CITROËN 027. Jumper 2014
 PEUGEOT 025. Boxer 2006
 PEUGEOT 027. Boxer 2014



025/504



S

M

L

b 025/555

71748247
8151LK



E3 011030
188x267 mm



c 025/557

71748251
8151LQ



E3 011030
185x78 mm



i 025/562

71748255
6325H4



81,3x129 mm

COVID

FIAT
CITROËN
PEUGEOT

FIAT.CITROËN.PEUGEOT

025/505

735661832
 (735620699)
 (735517079)
 (735480940)
 (735440423)

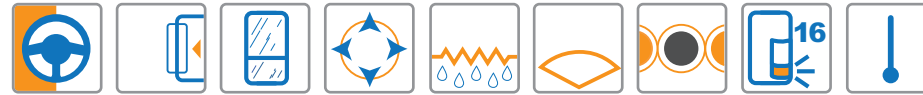

II (E3) 011029
 188x267 mm

1635685380
 (1613693180)
 (8154NC)

III (E3) 011029
 185x78 mm

(815463)
 (8153PP)

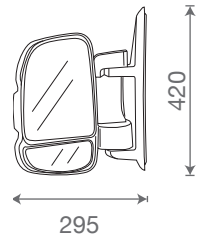

applicabilità:
 applicable to:
 Verwendbar für

FIAT 025. Ducato 2006
 FIAT 027. Ducato 2014
 CITROËN 025. Jumper 2006
 CITROËN 027. Jumper 2014
 PEUGEOT 025. Boxer 2006
 PEUGEOT 027. Boxer 2014



025/505



S

M

L

b 025/556



71748246
8151LI



E3 011029
188x267 mm

c 025/558



71748250
8151LP



E3 011029
185x78 mm

i 025/563

71748254
6325H3



81,3x129 mm

COVID

FIAT
CITROËN
PEUGEOT

FIAT.CITROËN.PEUGEOT

025/506

735620732
 (735517067)
 (735480915)
 (735440385)



1613691880
 (8154LQ)
 (815425)
 (8153NL)

II (E3) 011030
 188x267 mm

III (E3) 011030
 185x78 mm

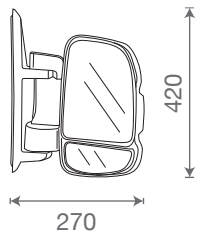

applicabilità:
 applicable to:
 Verwendbar für

FIAT 025. Ducato 2006
 FIAT 027. Ducato 2014
 CITROËN 025. Jumper 2006
 CITROËN 027. Jumper 2014
 PEUGEOT 025. Boxer 2006
 PEUGEOT 027. Boxer 2014



025/506



S

M

L

b 025/550



71748245
8151LH



E3 011030
188x267 mm

c 025/552



71748249
8151LN



E3 011030
185x78 mm

i 025/562

71748255
6325H4



81,3x129 mm

COVID

FIAT
CITROËN
PEUGEOT

suitable to FIAT.CITROËN.PEUGEOT

025/507

735620755
 (735517083)
 (735480944)
 (735440427)
 (735424438)



II (E3) 011029
 188x267 mm

1613693580
 (8154NH)
 (815467)
 (8153PT)
 (8153Y2)

III (E3) 011029
 185x78 mm

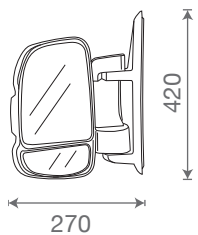

applicabilità:
 applicable to:
 Verwendbar für

FIAT 025. Ducato 2006
 FIAT 027. Ducato 2014
 CITROËN 025. Jumper 2006
 CITROËN 027. Jumper 2014
 PEUGEOT 025. Boxer 2006
 PEUGEOT 027. Boxer 2014



025/507



S

M

L

b 025/551



71748244
8151LG



E3 011029
188x267 mm

c 025/553



71748248
8151LL



E3 011029
185x78 mm

i 025/563

71748254
6325H3



81,3x129 mm

COVID

FIAT
CITROËN
PEUGEOT

suitable to FIAT.CITROËN.PEUGEOT

025/508

735620700
(735517068)
(735480916)
(735440388)

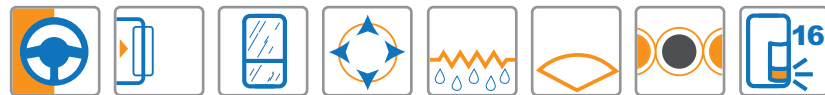

1613691980
(8154LR)
(815428)
(8153NQ)

II (E3) 011030
188x267 mm

III (E3) 011030
185x78 mm

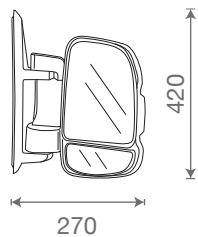

applicabilità:
applicable to:
Verwendbar für

FIAT 025. Ducato 2006
FIAT 027. Ducato 2014
CITROËN 025. Jumper 2006
CITROËN 027. Jumper 2014
PEUGEOT 025. Boxer 2006
PEUGEOT 027. Boxer 2014



025/508



S

M

L

b 025/555



71748247
8151LK



E3 011030
188x267 mm

c 025/557



71748251
8151LQ



E3 011030
185x78 mm

i 025/562

71748255
6325H4



81,3x129 mm

COVID

FIAT
CITROËN
PEUGEOT

suitable to FIAT.CITROËN.PEUGEOT

025/509

735675485
 (735620754)
 (735517082)
 (735480943)
 (735440426)



(E3) 011029
 188x267 mm

1613693480
 (8154NG)
 (815465)
 (8153PS)



(E3) 011029
 185x78 mm

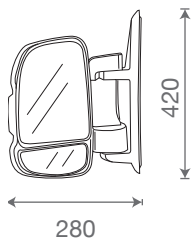

applicabilità:
 applicable to:
 Verwendbar für

FIAT 025. Ducato 2006
 FIAT 027. Ducato 2014
 CITROËN 025. Jumper 2006
 CITROËN 027. Jumper 2014
 PEUGEOT 025. Boxer 2006
 PEUGEOT 027. Boxer 2014



025/509



S

M

L

b 025/556

71748246
8151LI



E3 011029

188x267 mm



c 025/558

71748250
8151LP



E3 011029

185x78 mm



i 025/563

71748254
6325H3



81,3x129 mm

COVID

FIAT
CITROËN
PEUGEOT

suitable to FIAT.CITROËN.PEUGEOT

025/516

735620710
(735517042)
(735480888)
(735440389)
(735424398)



E3 011030

188x267 mm



E3 011030

185x78 mm

1613689380
(8154KT)
(815429)
(8153NR)
(8153W2)

applicabilità:
applicable to:
Verwendbar für

FIAT 025. Ducato 2006
FIAT 027. Ducato 2014
CITROËN 025. Jumper 2006
CITROËN 027. Jumper 2014
PEUGEOT 025. Boxer 2006
PEUGEOT 027. Boxer 2014

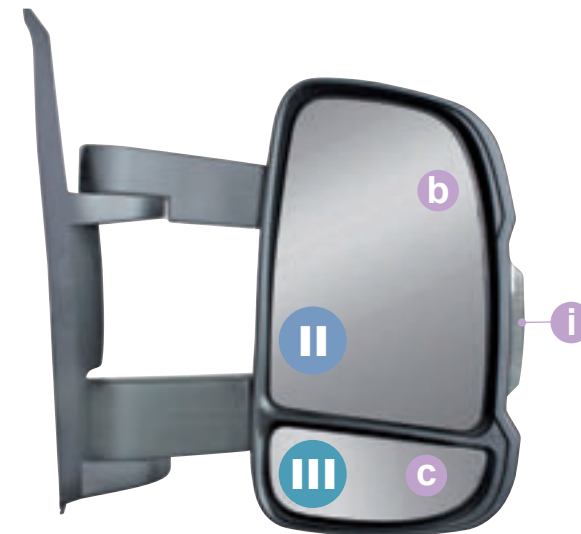
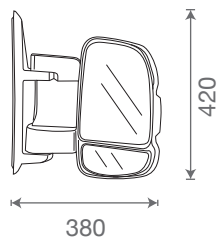

025/516



S
M
L

b 025/555



71748247
8151LK



E3 011030
188x267 mm

c 025/557



71748251
8151LQ



E3 011030
185x78 mm

i 025/562

71748255
6325H4



81,3x129 mm

COVID

FIAT
CITROËN
PEUGEOT

FIAT.CITROËN.PEUGEOT

025/517

735620752
 (735517080)
 (735480941)
 (735440424)
 (735424432)

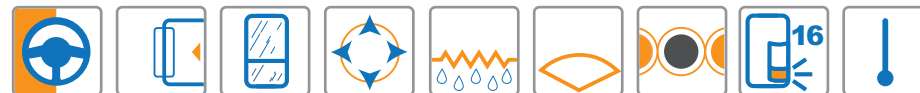

II

(E3) 011029

188x267 mm

1613693280
 (8154NE)
 (815464)
 (8153PQ)
 (8153X9)

III

(E3) 011029

185x78 mm

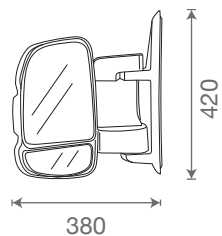

applicabilità:
 applicable to:
 Verwendbar für

FIAT 025. Ducato 2006
 FIAT 027. Ducato 2014
 CITROËN 025. Jumper 2006
 CITROËN 027. Jumper 2014
 PEUGEOT 025. Boxer 2006
 PEUGEOT 027. Boxer 2014

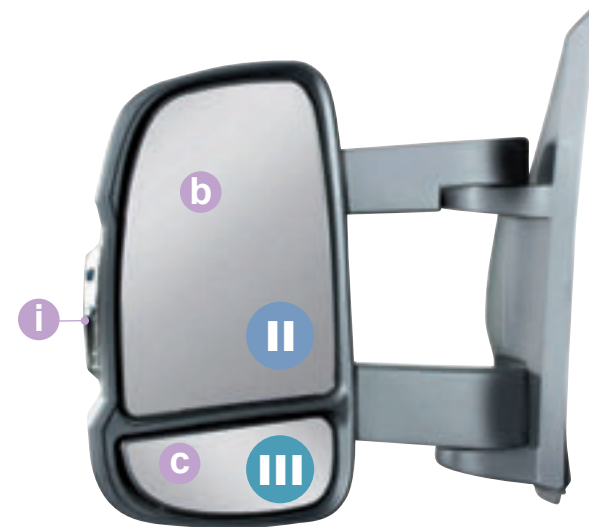

025/517



S

M

L

b 025/556

71748246
8151LI



E3 011029
188x267 mm



c 025/558

71748250
8151LP



E3 011029
185x78 mm



i 025/563

71748254
6325H3



81,3x129 mm

COVID

FIAT
CITROËN
PEUGEOT

suitable to FIAT.CITROËN.PEUGEOT

025/518

735620707
(735517039)
(735480885)
(735440386)
(735424395)



II (E3) 011030
188x267 mm

1613689080
(8154KQ)
(815477)
(8153NN)
(8153W0)

III (E3) 011030
185x78 mm

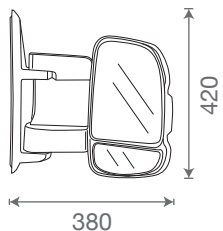

applicabilità:
applicable to:
Verwendbar für

FIAT 025. Ducato 2006
FIAT 027. Ducato 2014
CITROËN 025. Jumper 2006
CITROËN 027. Jumper 2014
PEUGEOT 025. Boxer 2006
PEUGEOT 027. Boxer 2014



025/518



S

M

L

b 025/550

71748245
8151LH



E3 011030

188x267 mm



c 025/552

71748249
8151LN



E3 011030

185x78 mm



i 025/562

71748255
6325H4



80,7x129 mm

COVID

FIAT
CITROËN
PEUGEOT

FIAT.CITROËN.PEUGEOT

025/519

735620749
 (735517074)
 (735480935)
 (735440418)
 1613692680



II (E3) 011029
 188x267 mm

(8154LY)
 (815458)
 (8153PK)

III (E3) 011029
 185x78 mm

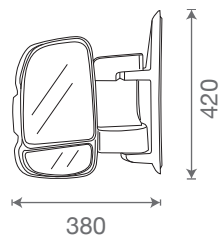

applicabilità:
 applicable to:
 Verwendbar für

FIAT 025. Ducato 2006
 FIAT 027. Ducato 2014
 CITROËN 025. Jumper 2006
 CITROËN 027. Jumper 2014
 PEUGEOT 025. Boxer 2006
 PEUGEOT 027. Boxer 2014



025/519



S
M
L

b 025/556

71748246
8151LI



E3 011029
188x267 mm



c 025/558

71748250
8151LP



E3 011029
78x185 mm



i 025/563

71748254
6325H3



80x129 mm

COVID

FIAT
CITROËN
PEUGEOT

suitable to FIAT.CITROËN.PEUGEOT

025/520

735620720
 (735517054)
 (735424408)
 (735480900)
 (735440401)



II (E3) 011030
 188x267 mm

1613690580
 (8154KY)
 (815441)
 (8153PY)
 (8153S2)

III (E3) 011030
 185x78 mm

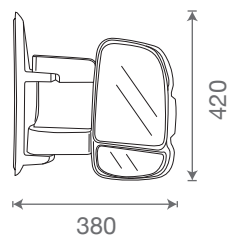

applicabilità:
 applicable to:
 Verwendbar für

FIAT 025. Ducato 2006
 FIAT 027. Ducato 2014
 CITROËN 025. Jumper 2006
 CITROËN 027. Jumper 2014
 PEUGEOT 025. Boxer 2006
 PEUGEOT 027. Boxer 2014

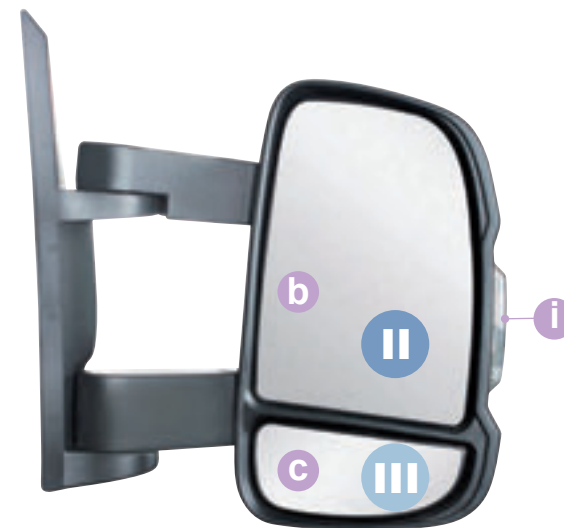

025/520



S
M
L

b 025/550

71748245
8151LH



E3 011030
188x267 mm



c 025/552

71745249
8151LN



E3 011030
185x78 mm



i 025/560

71748253
6325H1



81,3x129 mm

COVID

FIAT
CITROËN
PEUGEOT

FIAT.CITROËN.PEUGEOT

025/510

735620711
 (735517043)
 (735480889)
 (735440390)
 (735424399)



II (E3) 011030
 188x267 mm

1613689480
 (8154KV)
 (815430)
 (8153NS)
 (8153W3)

III (E3) 011030
 185x78 mm

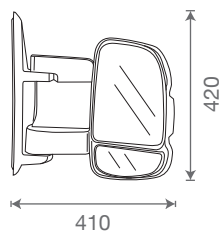

applicabilità:
 applicable to:
 Verwendbar für

FIAT 025. Ducato 2006
 FIAT 027. Ducato 2014
 CITROËN 025. Jumper 2006
 CITROËN 027. Jumper 2014
 PEUGEOT 025. Boxer 2006
 PEUGEOT 027. Boxer 2014



025/510



S
M
L

b 025/555

71748247
8151LK



E3 011030
188x267 mm



c 025/557

71748251
8151LQ



E3 011030
185x78 mm



i 025/562

71748255
6325H4



80,7x129 mm

COVID

FIAT
CITROËN
PEUGEOT

suitable to FIAT.CITROËN.PEUGEOT

025/511

735620750
 (735517075)
 (735480936)
 (735424425)
 (735440419)



(E3) 011029

188x267 mm

1613692780
 (8154LZ)
 (815459)
 (8153PL)
 (8153X6)



(E3) 011029

185x78 mm

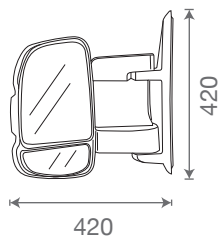

applicabilità:
 applicable to:
 Verwendbar für

FIAT 025. Ducato 2006
 FIAT 027. Ducato 2014
 CITROËN 025. Jumper 2006
 CITROËN 027. Jumper 2014
 PEUGEOT 025. Boxer 2006
 PEUGEOT 027. Boxer 2014

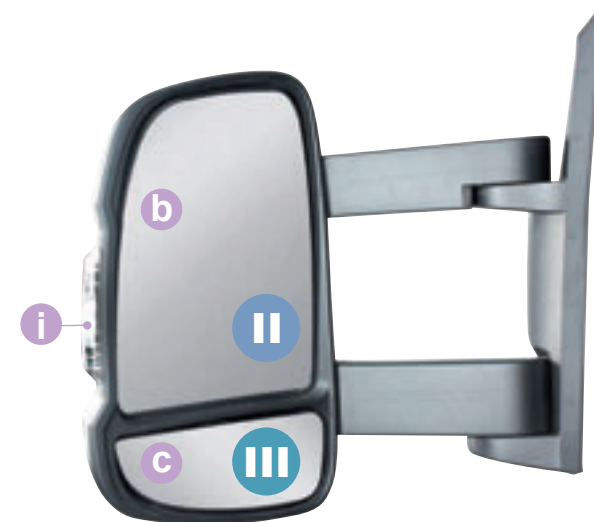

025/511



S
M
L

b 025/556

71748246
8151LI



E3 011029
188x267 mm



c 025/558

71748250
8151LP



E3 011029
185x78 mm



i 025/563

71748254
6325H3



80x129 mm

COVID

FIAT
CITROËN
PEUGEOT

FIAT.CITROËN.PEUGEOT

025/512



E3 011030

188x267 mm



E3 011030

185x78 mm

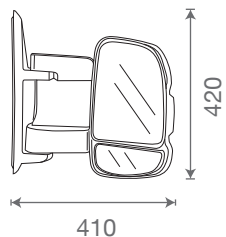

735620718

(735517052)

(735501134)

(735424406)

(735440399)

(735480898)

1613690380

(8154PH)

(815439)

(8153PE)

(8153X2)

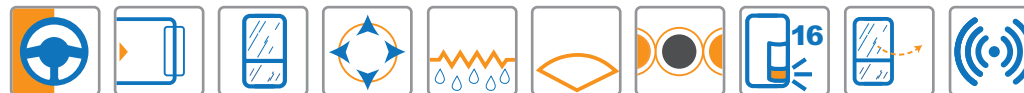

applicabilità:
applicable to:
Verwendbar für

FIAT 025. Ducato 2006

FIAT 027. Ducato 2014

CITROËN 025. Jumper 2006

CITROËN 027. Jumper 2014

PEUGEOT 025. Boxer 2006

PEUGEOT 027. Boxer 2014



025/512



S
M
L

b 025/555

71748247
8151LK



E3 011030
188x267 mm



c 025/557

71748251
8151LQ



E3 011030
185x78 mm



i 025/562

71748255
6325H4



81,3x129 mm

COVID

FIAT
CITROËN
PEUGEOT

FIAT.CITROËN.PEUGEOT

025/513

735620753
 (735517081)
 (735480942)
 (735424433)
 (735440425)

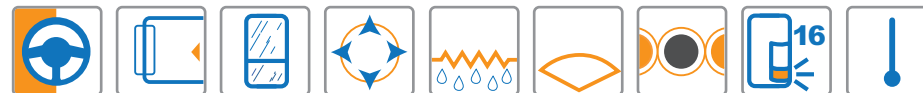

II

E3 011029

188x267 mm

1613693380
 (8154NF)
 (815466)
 (8153PR)
 (8153Y0)

III

E3 011029

185x78 mm

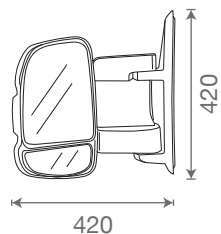

applicabilità:
 applicable to:
 Verwendbar für

FIAT 025. Ducato 2006
 FIAT 027. Ducato 2014
 CITROËN 025. Jumper 2006
 CITROËN 027. Jumper 2014
 PEUGEOT 025. Boxer 2006
 PEUGEOT 027. Boxer 2014



025/513



S
M
L

b 025/556

71748246
8151LI



E3 011029
188x267 mm



c 025/558

71748250
8151LP



E3 011029
185x78 mm



i 025/563

71748254
6325H3



80x129 mm

COVID

FIAT
CITROËN
PEUGEOT

FIAT.CITROËN.PEUGEOT

025/514

735620708
 (735517040)
 (735480886)
 (735424396)
 (735440387)



II (E3) 011030
 188x267 mm

1613689180
 (8154KR)
 (815427)
 (8153NP)
 (8153W1)

III (E3) 011030
 185x78 mm

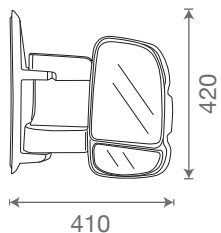

applicabilità:
 applicable to:
 Verwendbar für

FIAT 025. Ducato 2006
 FIAT 027. Ducato 2014
 CITROËN 025. Jumper 2006
 CITROËN 027. Jumper 2014
 PEUGEOT 025. Boxer 2006
 PEUGEOT 027. Boxer 2014

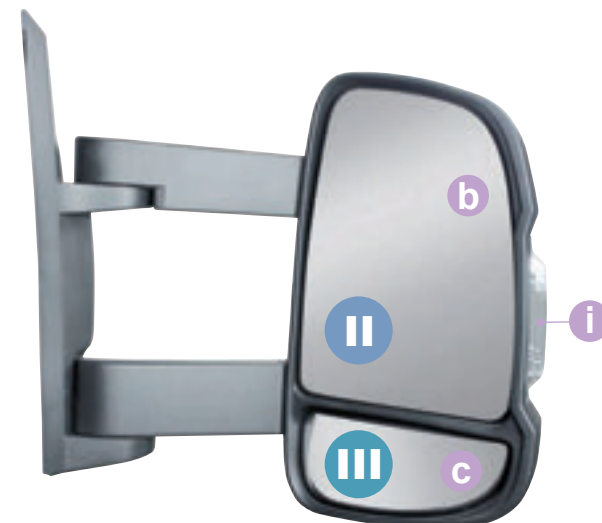

025/514



S
M
L

b 025/550

71748245
8151LH



E3 011030
188x267 mm



c 025/552

71748249
8151LN



E3 011030
185x78 mm



i 025/562

71748255
6325H4



80,7x129 mm

COVID

FIAT
CITROËN
PEUGEOT

FIAT.CITROËN.PEUGEOT

025/515

735620747
 (735517072)
 (735480933)
 (735424422)
 (735440416)



II 
 188x267 mm

1613692480
 (8154LW)
 (815456)
 (8153PH)
 (8153X4)

III  022876
 185x78 mm

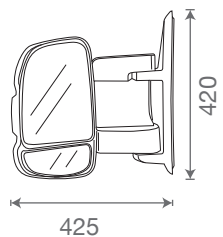

applicabilità:
 applicable to:
 Verwendbar für

FIAT 025. Ducato 2006
 FIAT 027. Ducato 2014
 CITROËN 025. Jumper 2006
 CITROËN 027. Jumper 2014
 PEUGEOT 025. Boxer 2006
 PEUGEOT 027. Boxer 2014

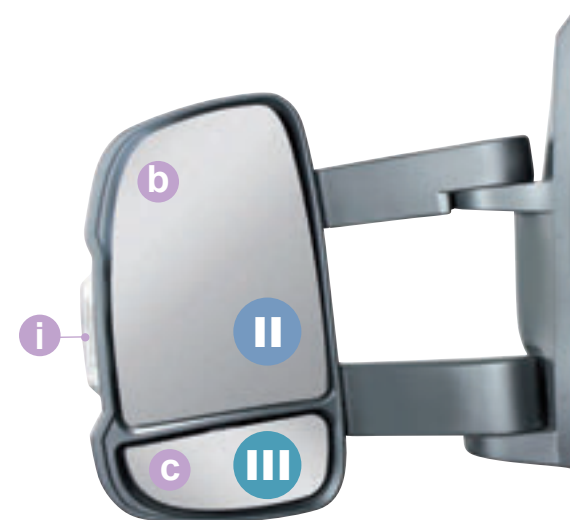

025/515



S
M
L

b 025/551

71748244
8151LG



-
188x267 mm



c 025/553

71748248
8151LL



E4 022876
185x78 mm



i 025/563

71748254
6325H3



80x129 mm

COVID

FIAT
CITROËN
PEUGEOT

FIAT.CITROËN.PEUGEOT

025/521

735620757
 (735517085)
 (735480946)
 (735424440)
 (735440429)



II



188x267 mm

1613693780
 (8154NK)
 (815469)
 (8153PW)
 (8153Y4)

III

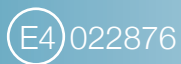

185x78 mm

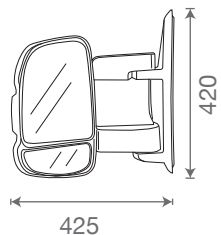

applicabilità:
 applicable to:
 Verwendbar für

FIAT 025. Ducato 2006
 FIAT 027. Ducato 2014
 CITROËN 025. Jumper 2006
 CITROËN 027. Jumper 2014
 PEUGEOT 025. Boxer 2006
 PEUGEOT 027. Boxer 2014



025/521



S
M
L

b 025/551

71748244
8151LG



188x267 mm



c 025/553

71748248
8151LL



E4 022876

185x78 mm



i 025/563

71748254
6325H3



80x129 mm

COVID

FIAT
CITROËN
PEUGEOT

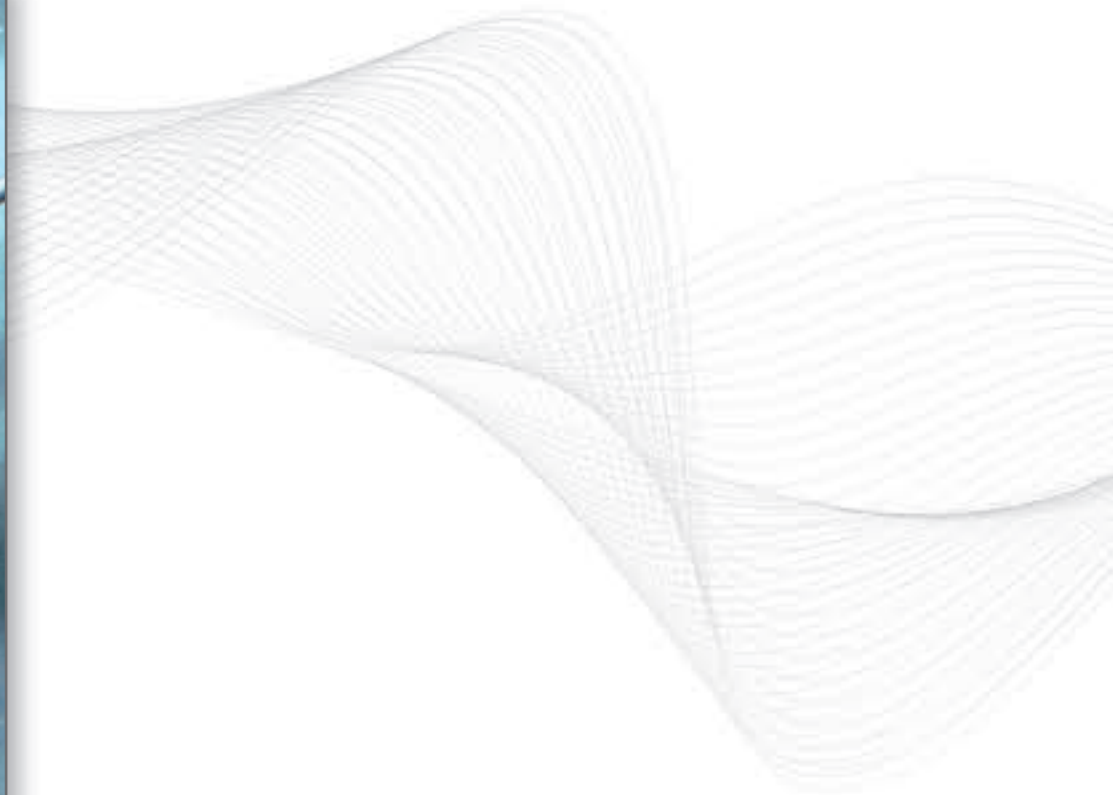
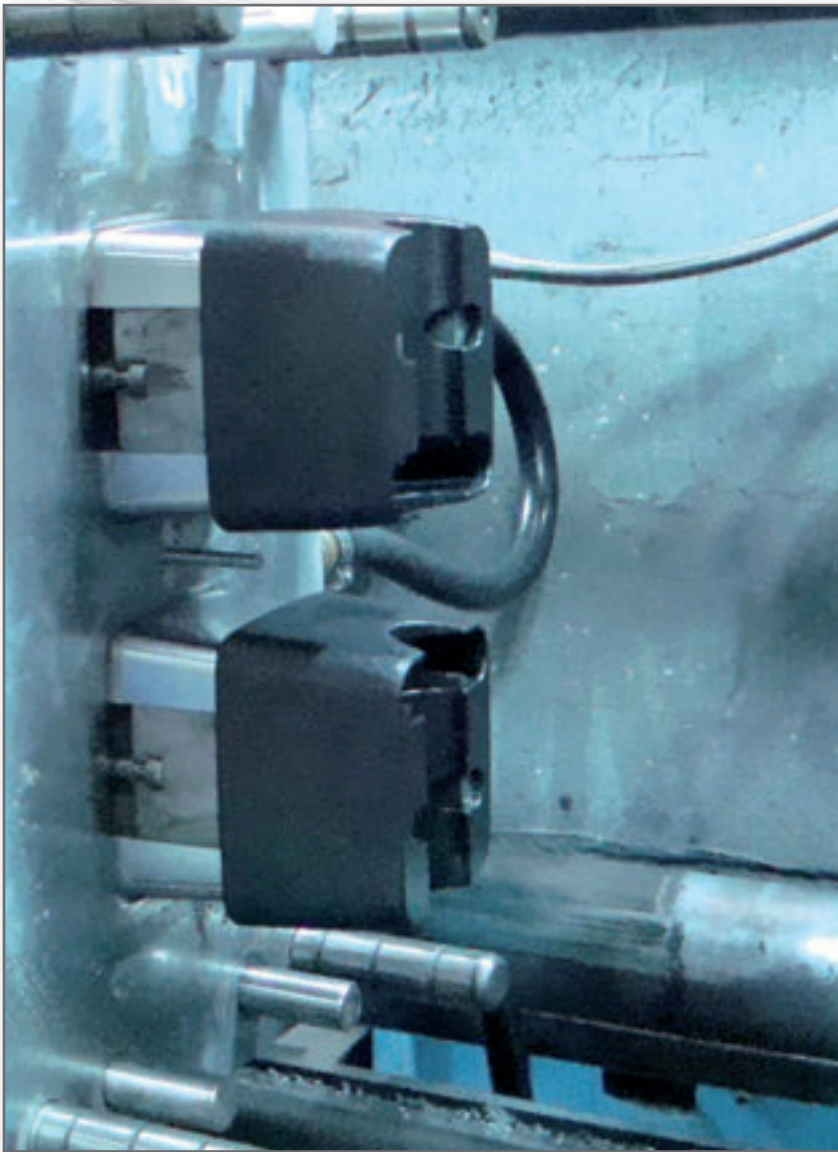

IT Progetto specchi retrovisori. Stampo per elemento di ancoraggio braccio in ABS
EN Rear - view mirrors project. Mould for ABS fixing arm
DE Rückspiegel-Projekt. Stahlform für ABS Bestandteil der Spiegelarmsverankerung

COVIND



suitable to

IVECO

suitable to

IVECO

D16/500

5802495904 ●
(5802029650) ●
(5801552549) ●



II

E9 036947

205x160mm

IV

105x145 mm

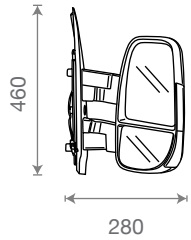

applicabilità:
applicable to:
Verwendbar für

IVECO D19. Daily 2019
IVECO D16. Daily 2016
IVECO D14. Daily 2014



D16/500

b	D14/550	5801823306			E9 036947 205x160 mm
	II				
c	D14/552	5801823346			105x145 mm
	IV				
d	D16/562	5801823823			
i	● D16/565	5802495899			90x68 mm
i	● D14/530	5801823334			90x68 mm



S

M

L



S

M

L



IVECO

suitable to

IVECO

D16/501

5802495903 ●
(5802029582) ●
(5801552548) ●



II

E9 036947

205x155 mm

IV

105x140 mm

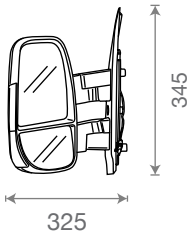











applicabilità:
applicable to:
Verwendbar für

IVECO D16. Daily 2016
IVECO D14. Daily 2014



D16/501

b D14/551 II	5801823992			E9 024362 185x205 mm
c D14/553 IV	5801823557			198x128 mm
d D16/563	5801823777			
i ● D16/566	5802495900			90x68 mm
i ● D14/531	5801823572			90x68 mm



S

M

L



S

M

L



IVECO

adattabile a **IVECO** suitable to

D14/500

5802028037
(5801552553)

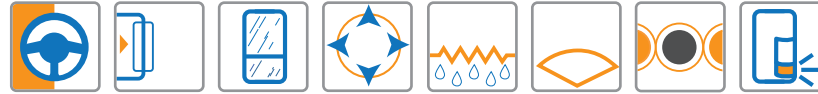

II

E9 036947
205x160 mm

IV

105x145 mm

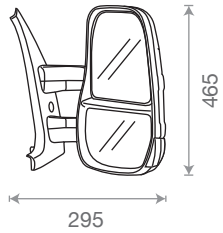

applicabilità:
applicable to:
Verwendbar für

IVECO D19. Daily 2019
IVECO D16. Daily 2016
IVECO D14. Daily 2014



D14/500

b D14/550

5801823306



E9 036947
205x160 mm

II

c D14/552

5801823346



105x145 mm

IV

d D14/554

5801823377



i D14/530

5801823334



205x100 mm



S

M

L



S

M

L



IVECO

adattabile a **IVECO** suitable to

D14/501

5802028036
(5801552552)

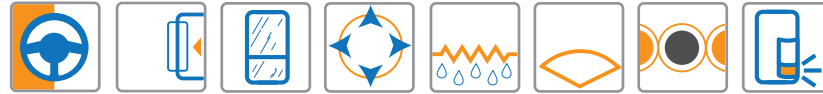

II

E9 036947
205x160 mm

IV

105x145 mm

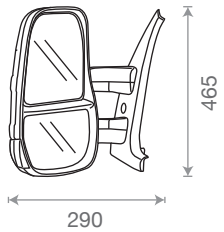

applicabilità:
applicable to:
Verwendbar für

IVECO D19. Daily 2019
IVECO D16. Daily 2016
IVECO D14. Daily 2014



D14/501

b D14/551

5801823992



E9 036947
205x160 mm

c D14/553

5801823557



105x145 mm

d D14/555

5801823582



i D14/531

5801823572



205x100 mm



S

M

L



S

M

L



IVECO

adattabile a **IVECO** suitable to

D14/505

5802028039
(5801552556)

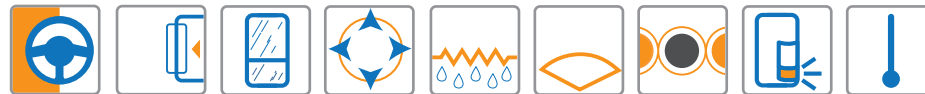

II

E9 036947
200x155 mm

IV

105x140 mm

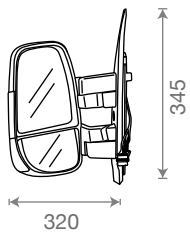

applicabilità:
applicable to:
Verwendbar für

IVECO D19. Daily 2019
IVECO D16. Daily 2016
IVECO D14. Daily 2014



D14/505

b D14/551

5801823992



E9 036947
205x160 mm

c D14/553

5801823557



105x145 mm

d D14/555

5801823582



i D14/531

5801823572



205x100 mm



S

M

L



S

M

L



IVECO

suitable to

IVECO

D14/508

5802495901 ●
(5802028034) ●
(5801552547) ●



II

E9 036947

205x160 mm

IV

105x145 mm

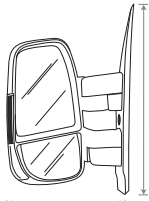

460











300

applicabilità:
applicable to:
Verwendbar für

IVECO D16. Daily 2016
IVECO D14. Daily 2014



D14/508

b	D14/550	5801823306			E9 036947 205x160 mm
	II				
c	D14/552	5801823346			105x145 mm
	IV				
d	D14/554	5801823377			
i	● D16/565	5802495899			90x68 mm
i	● D14/530	5801823334			205x100 mm



S

M

L



S

M

L



IVECO

COVINO

suitable to

IVECO

D14/509

5802495902 ●
(5802028033) ●
(5801552546) ●



II
E9 036947
205x160 mm

IV
105x145 mm

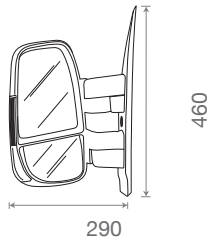

applicabilità:
applicable to:
Verwendbar für

IVECO D16. Daily 2016
IVECO D14. Daily 2014



D14/509

b	D14/551	5801823992			
	II				
c	D14/553	5801823557			105x145 mm
	IV				
d	D14/555	5801823582			
i	● D16/566	5802495900			90x68 mm
i	● D14/531	5801823572			205x100 mm



S

M

L



S

M

L



IVECO

adattabile a :: suitable to

D06/500

5802031932
 (5801755747)
 (5801367639)
 (3800414)

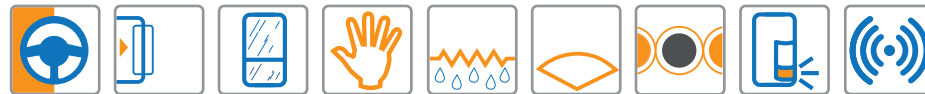

II

(E9) 024362
 185x205 mm

IV

(E9) 024353
 198x128 mm

applicabilità:
 applicable to:
 Verwendbar für

IVECO D12. Daily 2012
 IVECO D09. Daily 2009
 IVECO D06. Daily 2006

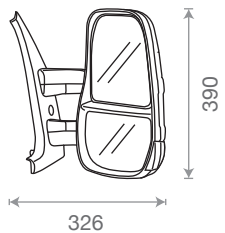

D06/500

b D06/550

3801927



E9 024362
185x205 mm

c D06/552

3801929



E9 024353
198x128 mm

d D06/554

3801911



f D06/556

3800501



i D06/426

3801915



90x68 mm



S

M

L



S

M

L



IVECO

suitable to

IVECO

D06/501

5802031837
(5801755695)
(5801367606)
(3800401)



II

E9 024362
185x205 mm

IV

E9 024353
198x128 mm

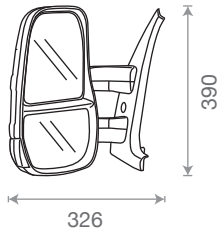

applicabilità:
applicable to:
Verwendbar für

IVECO D12. Daily 2012
IVECO D09. Daily 2009
IVECO D06. Daily 2006



D06/501

b D06/551

3801926



E9 024362

185x205 mm

c D06/553

3801928



E9 024353

198x128 mm

d D06/555

3801910



f D06/567

3800472



i D06/427

3801914



90x68 mm



S

M

L



S

M

L



IVECO

suitable to IVECO

D06/504

5802031936
(5801755754)
(5801367641)
(3800416)

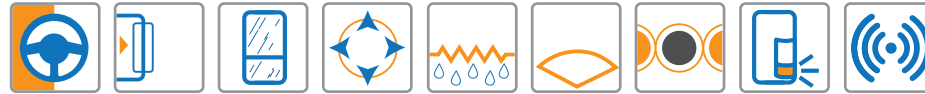

II

E9 024362

185x205 mm

IV

E9 024353

198x128 mm

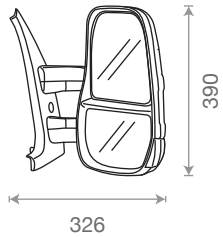





























applicabilità:
applicable to:
Verwendbar für

IVECO D12. Daily 2012
IVECO D09. Daily 2009
IVECO D06. Daily 2006



D06/504

b	D06/550 II	3801927		    	 E9 024362 185x205 mm
c	D06/552 IV	3801929		    	 E9 024353 198x128 mm
d	D06/554	3801911		   	
f	D06/556	3800501		   	
i	D06/426	3801915		   	90x68 mm



S

M

L



S

M

L



IVECO

suitable to

IVECO

D06/505

5802031928

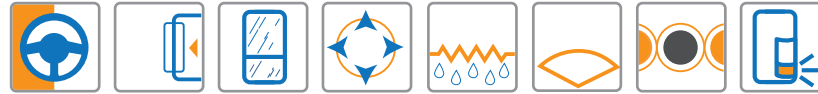

II

(E9) 024362

185x205 mm

IV

(E9) 024353

198x128 mm

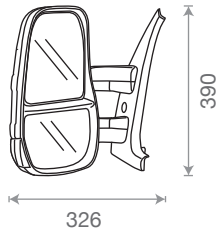











applicabilità:
applicable to:
Verwendbar für

IVECO D12. Daily 2012
IVECO D09. Daily 2009
IVECO D06. Daily 2006



D06/505

b	D06/551	3801926			E9 024362 185x205 mm
c	D06/553	3801928			E9 024353 198x128 mm
IV					
d	D06/555	3801910			
f	D06/567	3800472			
i	D06/427	3801914			90x68 mm



S

M

L



S

M

L



IVECO

COVINO

adattabile a :: suitable to

IVECO

D06/507

5802031845
(5801755713)
(5801367611)
(3800404)

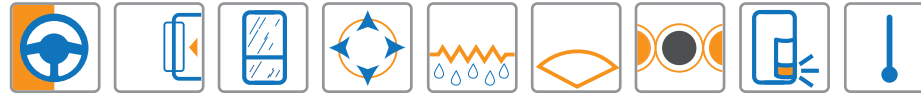

II

(E9) 024362

185x205 mm

IV

(E9) 024353

198x128 mm

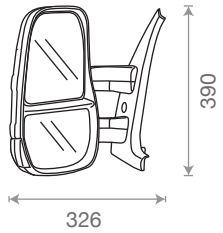

applicabilità:
applicable to:
Verwendbar für

IVECO D12. Daily 2012
IVECO D09. Daily 2009
IVECO D06. Daily 2006



D06/507

b D06/551

3801926



E9 024362
185x205 mm

II

c D06/553

3801928



E9 024353
198x128 mm

IV

d D06/555

3801910



f D06/567

3800472



i D06/427

3801914



90x68 mm



S

M

L



S

M

L



IVECO

adattabile a :: suitable to

IVECO

D06/509

5802031841
 (5801755712)
 (5801367610)
 (3800403)

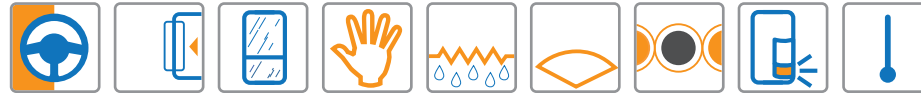

II (E9)024362
 185x205 mm

IV (E9)024353
 198x128 mm

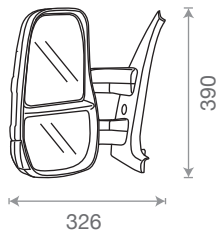

applicabilità:
 applicable to:
 Verwendbar für

IVECO D12. Daily 2012
 IVECO D09. Daily 2009
 IVECO D06. Daily 2006



D06/509

b D06/551

3801926



E9 024362
185x205 mm

c D06/553

3801928



E9 024353
198x128 mm

d D06/555

3801910



f D06/567

3800472



i D06/427

3801914



90x68 mm



S

M

L



S

M

L



IVECO

adattabile a :: suitable to

IVECO

D06/516

5802031849
(5801755722)
(5801367618)
(3800406)



II

E9 024362

185x205 mm

IV

E9 024353

198x128 mm

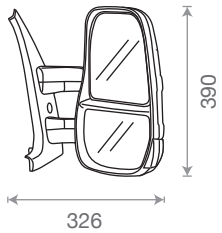

applicabilità:
applicable to:
Verwendbar für

IVECO D12. Daily 2012
IVECO D09. Daily 2009
IVECO D06. Daily 2006



D06/516

b D06/550

3801927



E9 024362
185x205 mm

c D06/552

3801929



E9 024353
198x128 mm

d D06/554

3801911



f D06/566

3800471



i D06/426

3801915



90x68 mm



S

M

L



S

M

L



IVECO

suitable to IVECO

D06/517

5802031923
(5801755740)
(5801367625)
(3800409)



II

(E9) 024362

185x205 mm

IV

(E9) 024353

198x128 mm

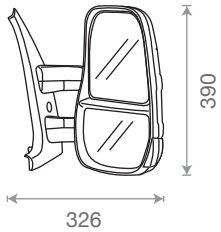

applicabilità:
applicable to:
Verwendbar für

IVECO D12. Daily 2012
IVECO D09. Daily 2009
IVECO D06. Daily 2006

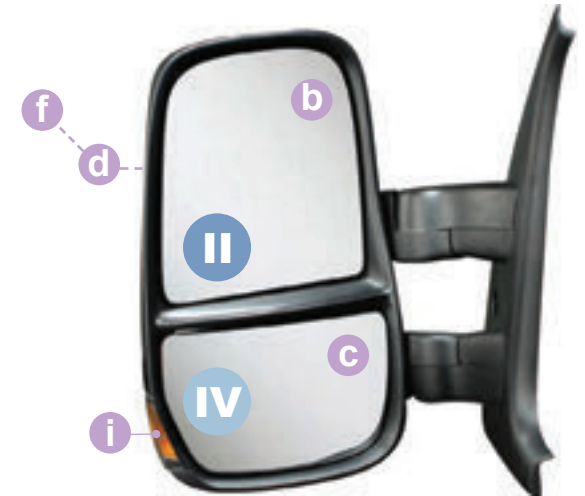

D06/517

b D06/551

3801926



E9 024362
185x205 mm

c D06/553

3801928



E9 024353
198x128 mm

d D06/555

3801910



f D06/557

3800500



i D06/427

3801914



90x68 mm



S

M

L



S

M

L



IVECO

suitable to

IVECO

D06/519

5802031838
(5801755709)
(5801367608)
(3800402)

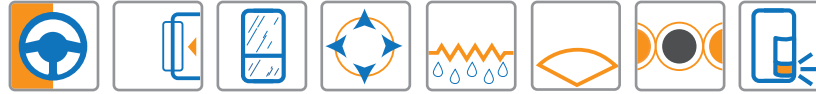

II

(E9)024362

185x205 mm

IV

(E9)024353

198x128 mm

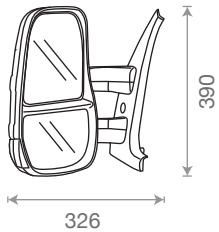

applicabilità:
applicable to:
Verwendbar für

IVECO D12. Daily 2012
IVECO D09. Daily 2009
IVECO D06. Daily 2006



D06/519

b D06/551

3801926



E9 024362
185x205 mm

c D06/553

3801928



E9 024353
198x128 mm

d D06/555

3801910



f D06/567

3800472



i D06/427

3801914



90x68 mm



S

M

L



S

M

L



IVECO

038/500

93924653

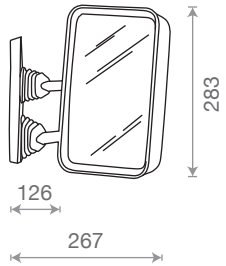

applicabilità:
applicable to:
Verwendbar für

IVECO 038. New Daily 1996

IVECO 038. New Daily



038/501

93924654

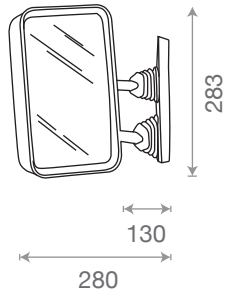

applicabilità:
applicable to:
Verwendbar für

IVECO 038. NEW DAILY 1996
IVECO 038. NEW DAILY



S

M

L



S

M

L



suitable to

IVECO

C39/502

500325726



E3 0156268

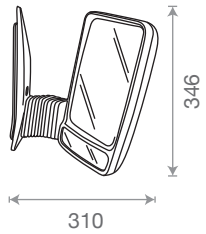

applicabilità:
applicable to:
Verwendbar für

IVECO C39. Daily S2000



C39/503

500325725



|| E3 0156268

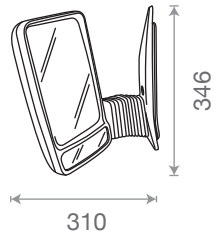

applicabilità:
applicable to:
Verwendbar für

IVECO C39. Daily S2000



S

M

L



S

M

L



adattabile a **IVECO** suitable to

D16/502

5802029805
(5801687178)



II

E9 024362
205x185 mm

IV

E9 024353
130x200 mm

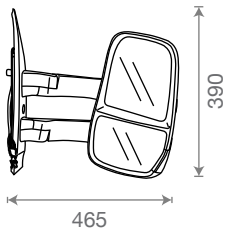

applicabilità:
applicable to:
Verwendbar für

IVECO D19. Daily 2019
IVECO D16. Daily 2016
IVECO D14. Daily 2014



D16/502

b

D06/550

3801927



E9 024362
185x205 mm

c

D06/552

3801929



E9 024353
198x128 mm

d

D16/558

5801822982



f

i

D06/426

3801915



90x68 mm



S

M

L



S

M

L



IVECO

adattabile a **IVECO** suitable to

D16/503

5802029799
(5801681268)

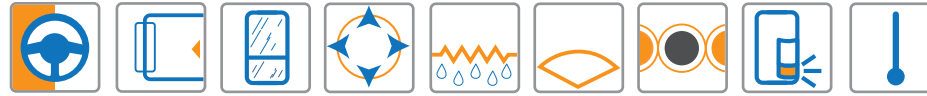

II

E9 024362
205x185 mm

IV

E9 024353
130x200 mm

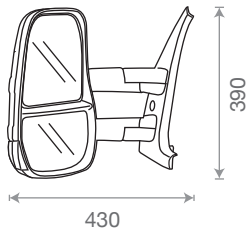

applicabilità:
applicable to:
Verwendbar für

IVECO D16. Daily 2016
IVECO D14. Daily 2014



D16/503

b D06/551
II

3801926



E9 024362
185x205 mm

c D06/553
IV

3801928



E9 024353
198x128 mm

d D16/555

5801822999



f D16/557

5801822996



i D06/427

3801914



90x68 mm



S

M

L



S

M

L



IVECO

suitable to

IVECO

D16/510

5802029798
(5801679492)

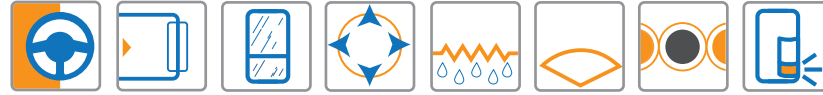

II

E9 024362
205x185 mm

IV

E9 024353
130x200 mm

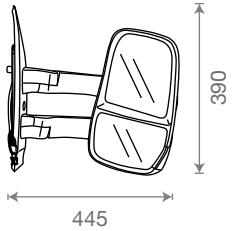

applicabilità:
applicable to:
Verwendbar für

IVECO D19. Daily 2019
IVECO D16. Daily 2016
IVECO D14. Daily 2014



D16/510

b D06/550

3801927



E9 024362
185x205 mm

c D06/552

3801929



E9 024353
198x128 mm

d D16/558

5801822982



f D16/560

5801822986



i D06/426

3801915



90x68 mm



S

M

L



S

M

L



IVECO

suitable to

IVECO

D16/511

5802029776
(5801679491)

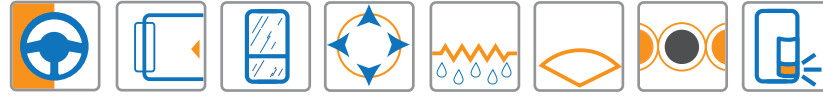

II

E9 024362
205x185 mm

IV

E9 024353
130x200 mm

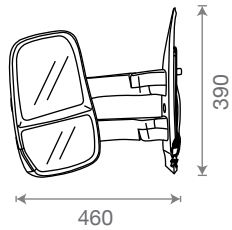

applicabilità:
applicable to:
Verwendbar für

IVECO D19. Daily 2019
IVECO D16. Daily 2016
IVECO D14. Daily 2014



D16/511

b D06/551

3801926



E9 024362
185x205 mm

c D06/553

3801928



E9 024353
198x128 mm

d D16/555

5801822999



f D16/557

5801822996



i D06/427

3801914



90x68 mm



S

M

L



S

M

L



IVECO

suitable to

IVECO

D14/502

5802029773
(5801679489)



II

(E9) 024362
205x185 mm

IV

(E9) 024353
130x200 mm

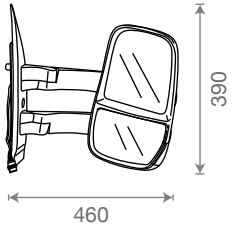

applicabilità:
applicable to:
Verwendbar für

IVECO D19. Daily 2019
IVECO D16. Daily 2016
IVECO D14. Daily 2014

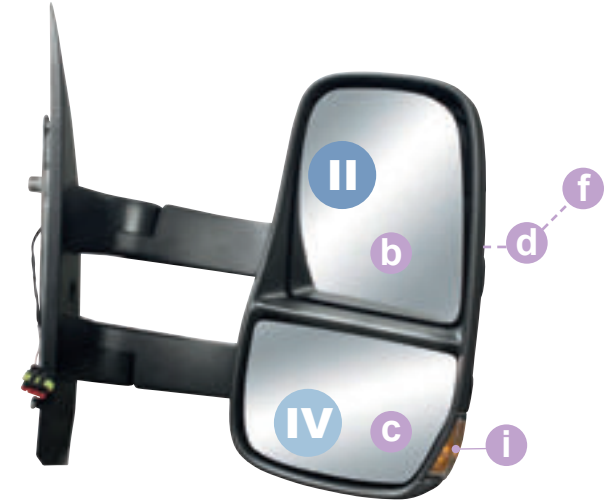

D14/502

b D06/550

3801927



E9 024362
185x205 mm

c D06/552

3801929



E9 024353
198x128 mm

d D16/558

5801822982



f D16/560

5801822986



i D06/426

3801915



90x68 mm



S

M

L



S

M

L



IVECO

suitable to

IVECO

D14/503

5802029774
(5801687143)

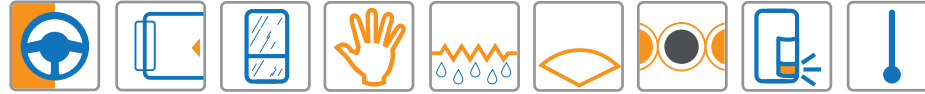

II

E9 024362
205x185 mm

IV

E9 024353
130x200 mm

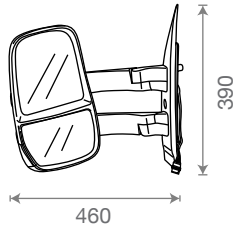

applicabilità:
applicable to:
Verwendbar für

IVECO D19. Daily 2019
IVECO D16. Daily 2016
IVECO D14. Daily 2014



D14/503

b D06/551
II

3801926



E9 024362
185x205 mm

c D06/553
IV

3801928



E9 024353
198x128 mm

d D16/555

5801822999



f D16/557

5801822996



i D06/427

3801914



90x68 mm



S

M

L



S

M

L



IVECO

adattabile a **IVECO** suitable to

D06/502

5802032046
(5801736697)
(5801367569)
(3800425)

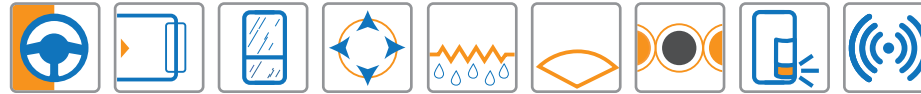

II

E9 024362
185x205 mm

IV

E9 024353
198x128 mm

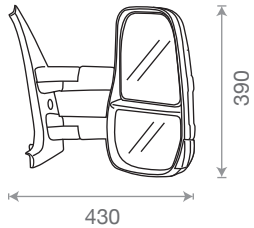



























applicabilità:
applicable to:
Verwendbar für

IVECO D12. Daily 2012
IVECO D09. Daily 2009
IVECO D06. Daily 2006



D06/502

b	D06/550 II	3801927		    	E9 024362 185x205 mm
c	D06/552 IV	3801929		    	E9 024353 198x128 mm
d	D06/554	3801911		   	
f	D12/558	3800473		   	
i	D06/426	3801915		   	90x68 mm



S

M

L



S

M

L



IVECO

suitable to

IVECO

D06/503

5802032049
(5801736702)
(5801367573)
(3800429)

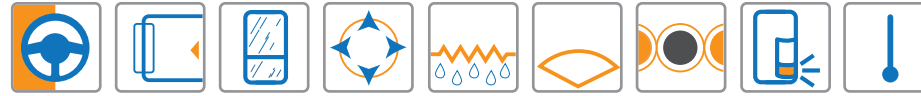

II (E9) 024362
185x205 mm

IV (E9) 024353
198x128 mm

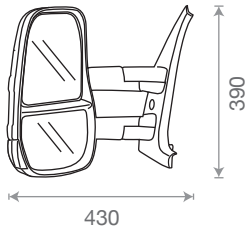



























applicabilità:
applicable to:
Verwendbar für

IVECO D12. Daily 2012
IVECO D09. Daily 2009
IVECO D06. Daily 2006



D06/503

b	D06/551 II	3801926		    	E9 024362 185x205 mm
c	D06/553 IV	3801928		    	E9 024353 198x128 mm
d	D06/555	3801910		   	390x220 mm
f	D06/559	3800503		   	
i	D06/427	3801914		   	90x68 mm



S

M

L



S

M

L



IVECO

adattabile a **IVECO** suitable to

D06/510

5802032043
(5801736704)
(5801367567)
(3800423)



II

E9 024362
185x205 mm

IV

E9 024353
198x128 mm

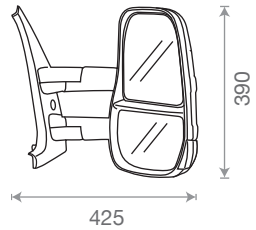

applicabilità:
applicable to:
Verwendbar für

IVECO D12. Daily 2012
IVECO D09. Daily 2009
IVECO D06. Daily 2006



D06/510

b D06/550
II

3801927



E9 024362
185x205 mm

c D06/552
IV

3801929



E9 024353
198x128 mm

d D06/554

3801911



f D12/558

3800473



i D06/426

3801915



90x68 mm



S

M

L



S

M

L



IVECO

suitable to

IVECO

D06/511

5802032045
(5801736705)
(5801367571)
(3800427)

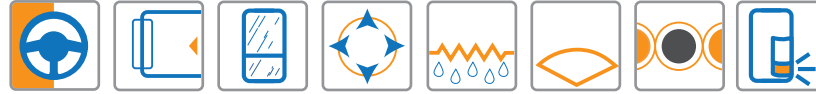

II

E9 024362
185x205 mm

IV

E9 024353
198x128 mm

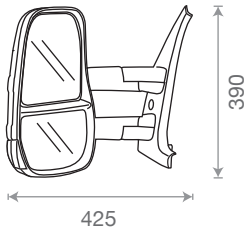















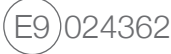





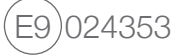







applicabilità:
applicable to:
Verwendbar für

IVECO D12. Daily 2012
IVECO D09. Daily 2009
IVECO D06. Daily 2006



D06/511

b	D06/551	3801926		    	 185x205 mm
c	D06/553	3801928		    	 198x128 mm
d	D06/555	3801910		   	
f	D06/559	3800503		   	
i	D06/427	3801914		   	90x68 mm



S

M

L



S

M

L



IVECO

suitable to

IVECO

D06/513

5802032040
(5801736695)
(5801367570)
(3800426)



II

E9 024362

185x205 mm

IV

E9 024353

198x128 mm

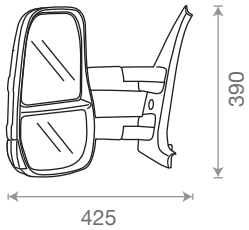



applicabilità:
applicable to:
Verwendbar für

IVECO D12. Daily 2012
IVECO D09. Daily 2009
IVECO D06. Daily 2006



D06/513

b D06/551 3801926      E9 024362
185x205 mm

c D06/553 3801928      E9 024353
198x128 mm

d D06/555 3801910     

f D06/559 3800503     

i D06/427 3801914     

90x68 mm



S

M

L



S

M

L



IVECO

038/502

93928072

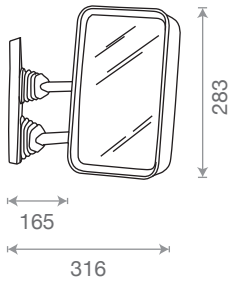

applicabilità:
applicable to:
Verwendbar für

IVECO 038. New Daily 1996
IVECO 038. New Daily



038/503

93928073

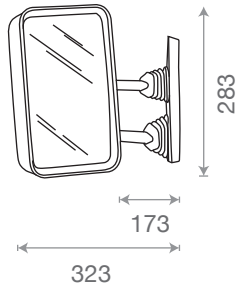

applicabilità:
applicable to:
Verwendbar für

IVECO 038. New Daily 1996

IVECO 038. New Daily



S

M

L



S

M

L



038/506

93936843

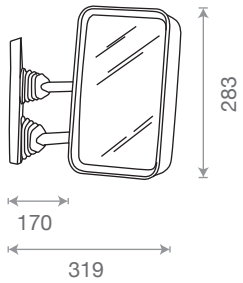

applicabilità:
applicable to:
Verwendbar für

IVECO 038. New Daily 1996



038/507

93936842

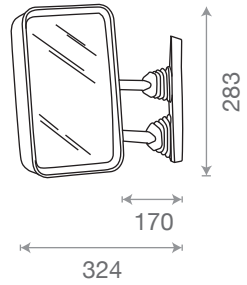

applicabilità:
applicable to:
Verwendbar für

IVECO 038. New Daily 1996



S
M
L



S
M
L



D14/ 15

5801511735



applicabilità:
applicable to:
Verwendbar für

IVECO D19. Daily 2019
IVECO D16. Daily 2016
IVECO D14. Daily 2014



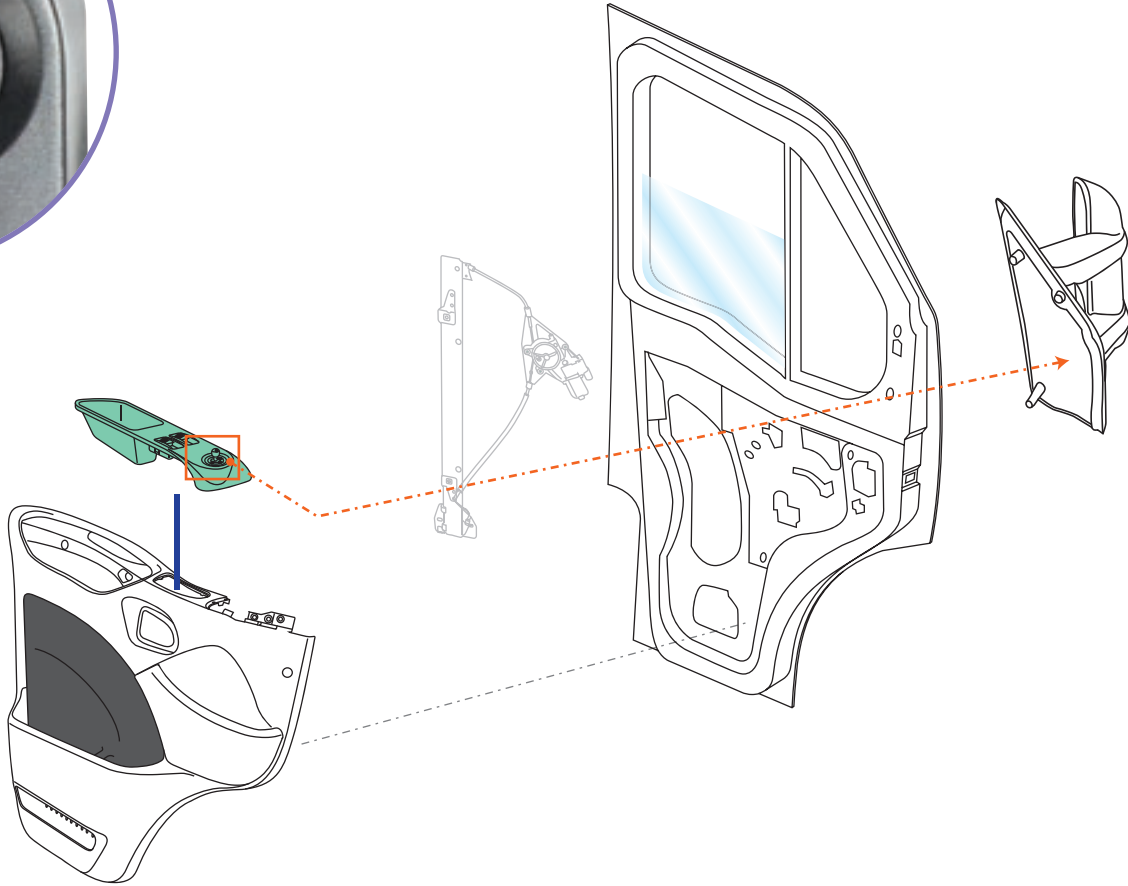

S
M
L



S
M
L



COVIND

IVECO

D12/ 15

5801484207
(5801399646)



applicabilità:
applicable to:
Verwendbar für

IVECO D12. Daily 2012



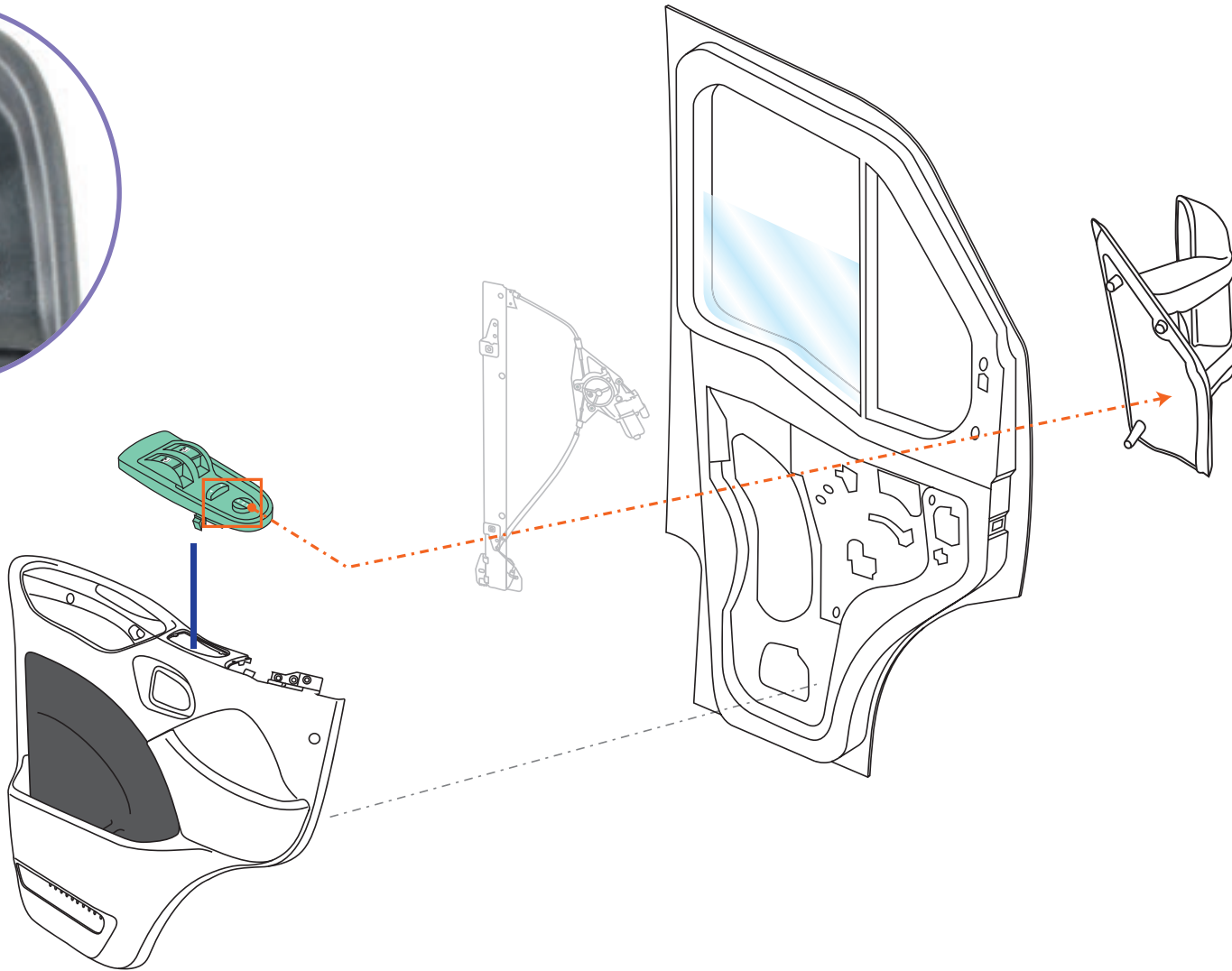

S
M
L



S
M
L



IVECO

COVIND

suitable to

IVECO

D06/ 16

5801304491
(69500478)



applicabilità:
applicable to:
Verwendbar für

IVECO D09. Daily 2009
IVECO D06. Daily 2006



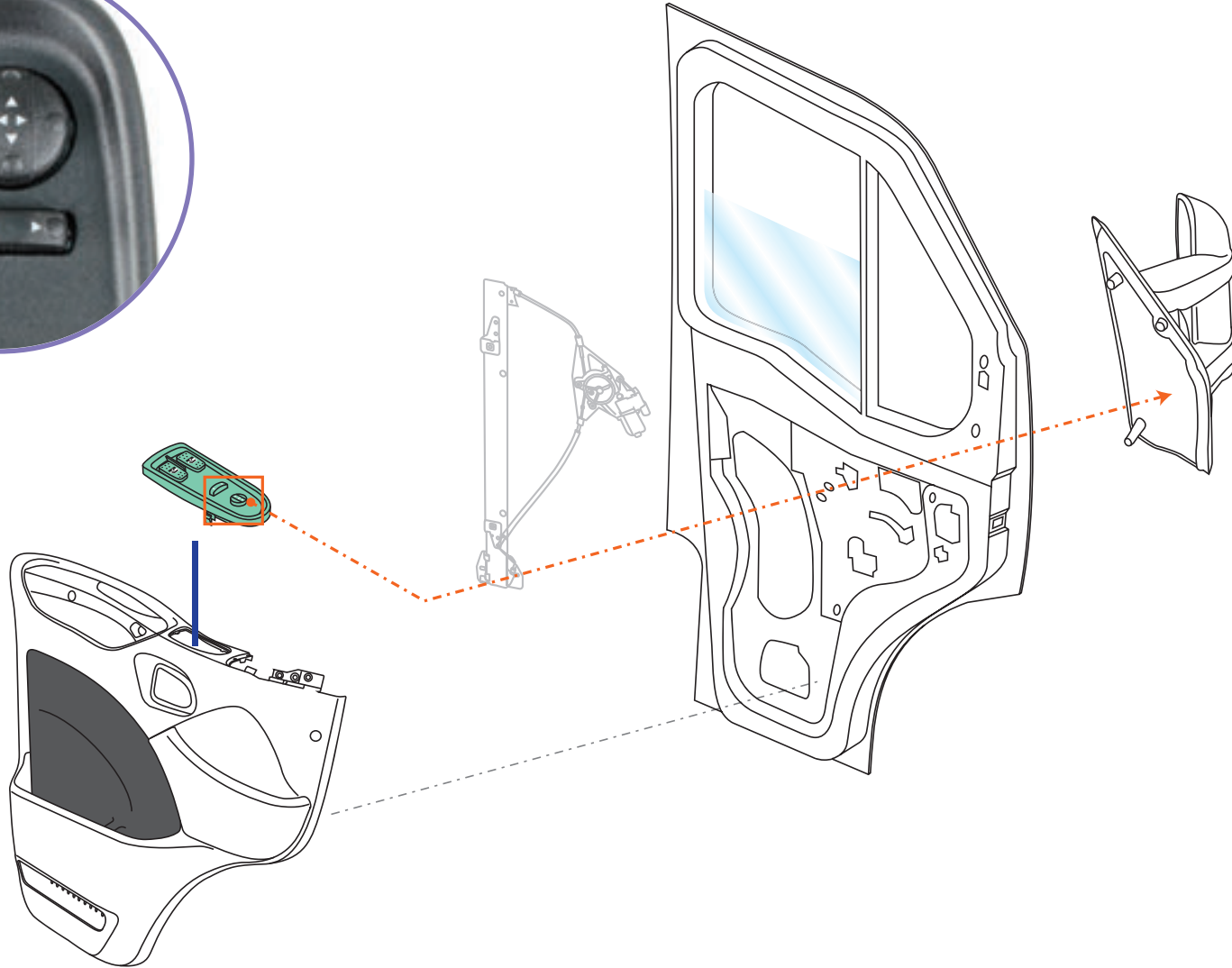

S
M
L



S
M
L



COVIND

IVECO

C39/ 24

500321136



applicabilità:
applicable to:
Verwendbar für

IVECO C39. Daily 2000





S
M
L



S
M
L



IVECO

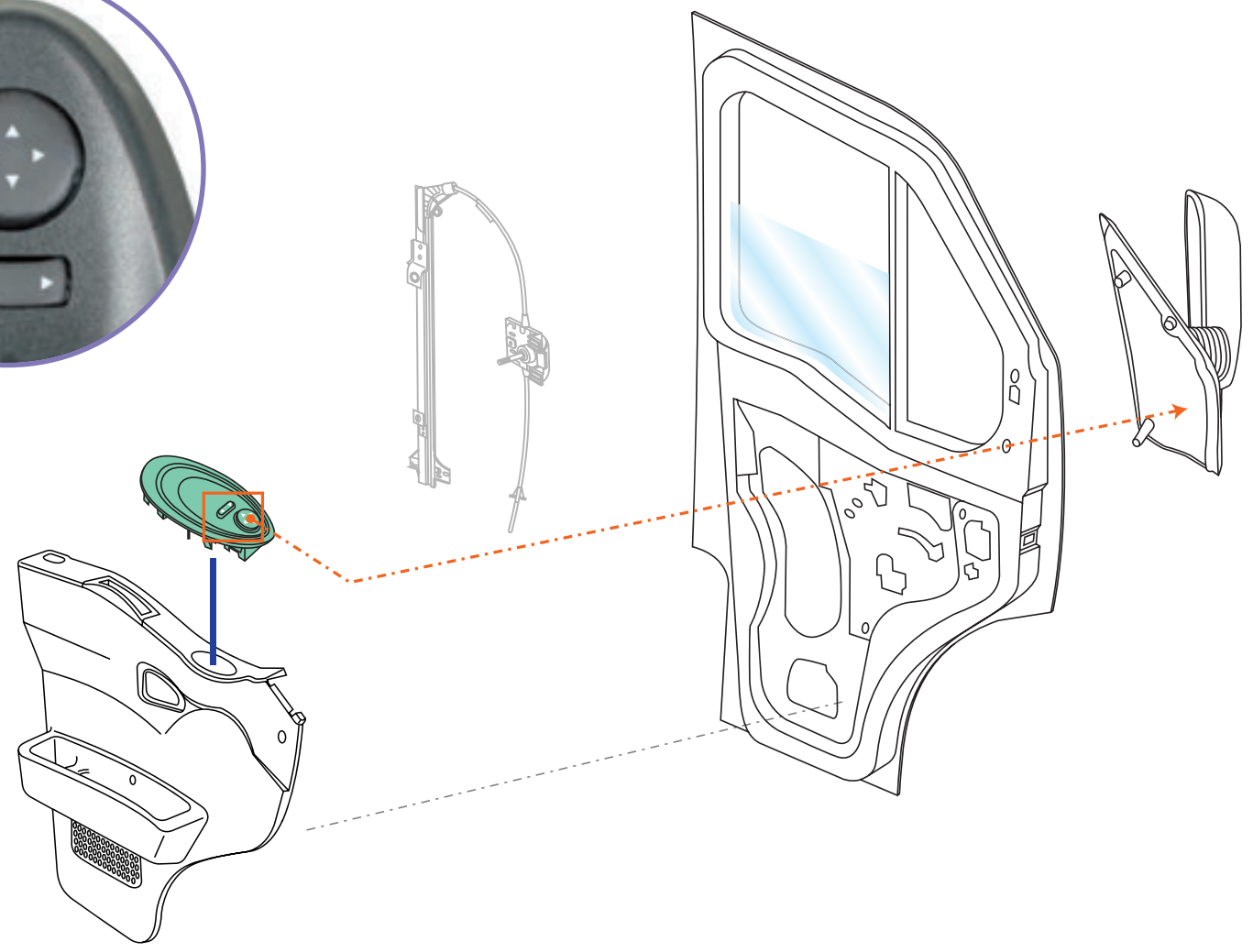

COVIND

adattabile a :: suitable to

IVECO

560/500

5801765196
 (5801580202)
 (5801334610)
 (504369961)
 (504150527)



II

(E4) 024098

181x371 mm

IV

(E4) 024099

192x206 mm

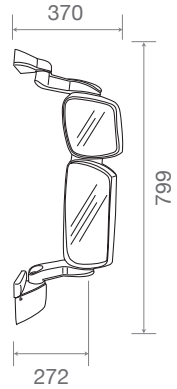

applicabilità:
 applicable to:
 Verwendbar für



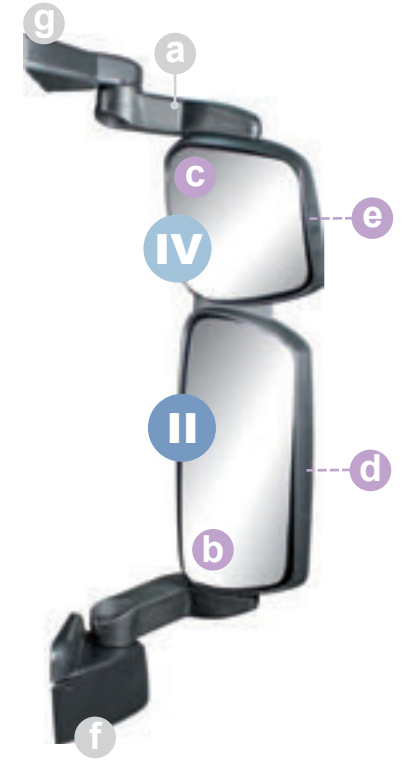





- IVECO 195. Eurocargo 2015
- IVECO 095. Eurocargo 2008
- IVECO 075. Tector Restyling 04/2006→
- IVECO 225. Eurocargo 2015
- IVECO 135. Eurocargo 2008
- IVECO 125. Tector Restyling 04/2006→
- IVECO 155. Tector Restyling 04/2006→
- IVECO XWY. AS X-Way
- IVECO 580. AS Stralis 2013
- IVECO 560. AS Stralis 2007
- IVECO 540. AS Stralis 04/2006→



II

IV

560/500

a	-	-				
b	560/509 II	2997667 (504159282) (504197878) (504159284) (504159286)				E4 024098 181x371 mm
c	095/505 IV	2997668 (504197879)				E4 024099 192x206 mm
d	560/504 II	504158975				246x383 mm
e	095/506 IV	504158977				242x230 mm
f	-	-				
g	-	-				



S

M

L



S

M

L



IVECO

COVINO

suitable to

IVECO

560/501

5801765195
 (5801580201)
 (5801334614)
 (504369910)
 (504150526)



II

E4 024098

181x371 mm

IV

E4 024099

192x206 mm

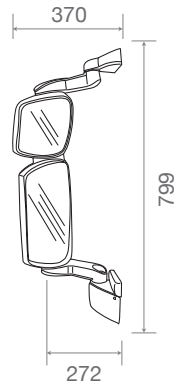

applicabilità:
 applicable to:
 Verwendbar für



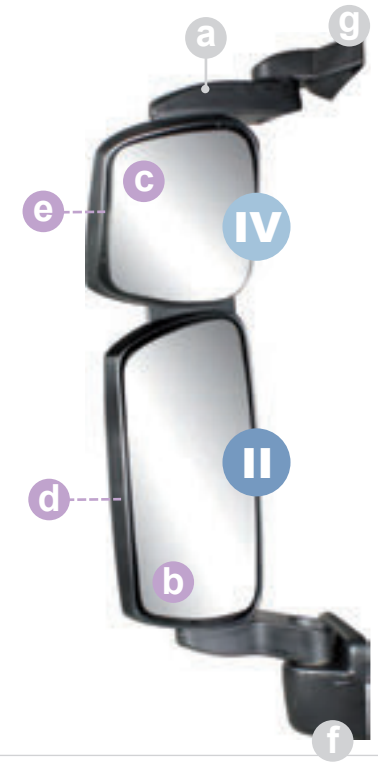





IVECO 195. Eurocargo 2015
 IVECO 095. Eurocargo 2008
 IVECO 075. Tector Restyling 04/2006→
 IVECO 225. Eurocargo 2015
 IVECO 135. Eurocargo 2008
 IVECO 125. Tector Restyling 04/2006→
 IVECO 155. Tector Restyling 04/2006→
 IVECO XWY. AS X-Way
 IVECO 580. AS Stralis 2013
 IVECO 560. AS Stralis 2007
 IVECO 540. AS Stralis 04/2006→



II

IV

560/501

a	-	-			
b	560/509 II	2997667 (504159282) (504197878) (504159284) (504159286)		    	E4 024098 181x371 mm
c	095/505 IV	2997668 (504197879)		    	E4 024099 192x206 mm
d	560/505 II	504158974		   	246x383 mm
e	095/507 IV	504158976		   	242x230 mm
f	-	-			
g	-	-			

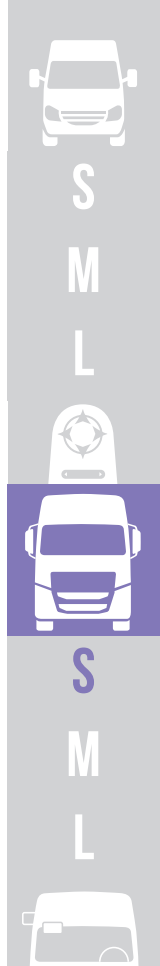

suitable to

IVECO

560/502

5801765318
 (5801580230)
 (5801336298)
 (504370055)
 (504150539)



II

E4 024098

181x371 mm



IV

E4 024099

192x206 mm

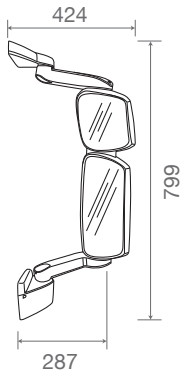

applicabilità:
 applicable to:
 Verwendbar für



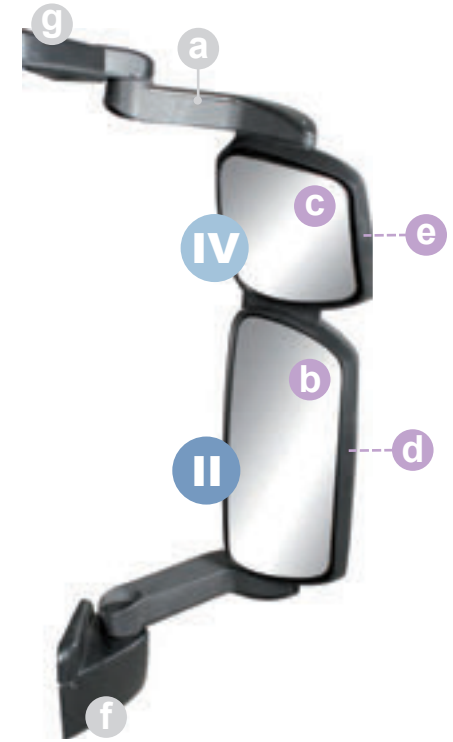



















IVECO 195. Eurocargo 2015
 IVECO 095. Eurocargo 2008
 IVECO 075. Tector Restyling 04/2006→
 IVECO 225. Eurocargo 2015
 IVECO 135. Eurocargo 2008
 IVECO 125. Tector Restyling 04/2006→
 IVECO 155. Tector Restyling 04/2006→
 IVECO XWY. AD/AT X-Way
 IVECO 570. AD/AT Stralis 2013
 IVECO 550. AD/AT Stralis 2007
 IVECO 530. AD/AT Stralis 04/2006→
 IVECO 545. AD/AT Trakker 04/2006→



II

IV

560/502

a	-	-				
b	560/509 II	2997667 (504159282) (504197878) (504159284) (504159286)		    	E4 024098 181x371 mm	
c	095/505 IV	2997668 (504197879)		    	E4 024099 192x206 mm	
d	560/504 II	504158975		   	246x383 mm	
e	095/506 IV	504158977		   	242x230 mm	
f	-	-				
g	-	-				



S

M

L



S

M

L



IVECO

COVINO

suitable to

IVECO

560/503

5801765315
 (5801580228)
 (5801336285)
 (504370048)
 (504150538)



II

E4 024098

181x371 mm



IV

E4 024099

191x206 mm

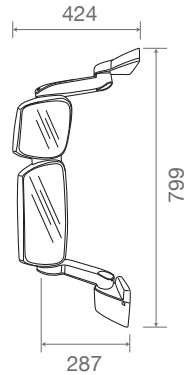

applicabilità:
 applicable to:
 Verwendbar für



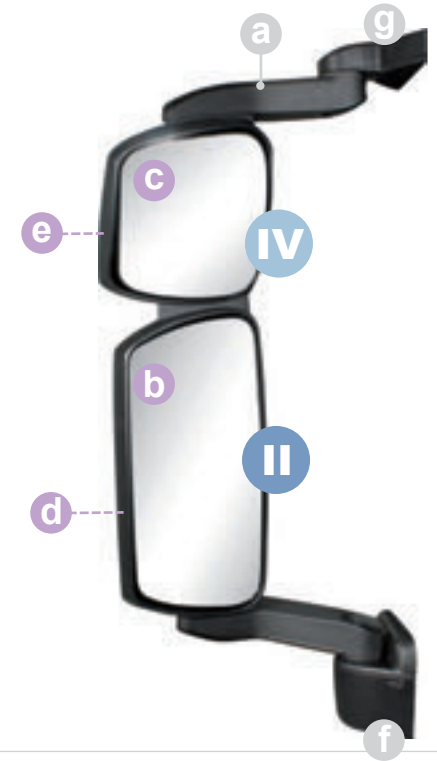













IVECO 195. Eurocargo 2015
 IVECO 095. Eurocargo 2008
 IVECO 075. Tector Restyling 04/2006→
 IVECO 225. Eurocargo 2015
 IVECO 135. Eurocargo 2008
 IVECO 125. Tector Restyling 04/2006→
 IVECO 155. Tector Restyling 04/2006→
 IVECO XWY. AD/AT X-Way
 IVECO 570. AD/AT Stralis 2013
 IVECO 550. AD/AT Stralis 2007
 IVECO 530. AD/AT Stralis 04/2006→
 IVECO 545. AD/AT Trakker 04/2006→



II

IV

560/503

a	-	-								
b	560/509 II	2997667 (504159282) (504197878) (504159284) (504159286)							E4 024098	181x371 mm
c	095/505 IV	2997668 (504197879)							E4 024099	192x206 mm
d	560/505 II	504158974								246x383 mm
e	095/507 IV	504158976								242x230 mm
f	-	-								
g	-	-								



suitable to

IVECO

II

03 022094

03 022096

03 022097

185 x 330 mm

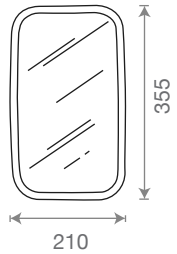

applicabilità:
applicable to:
Verwendbar für

IVECO 060. Eurocargo
IVECO 120. Eurocargo
IVECO 150. Eurocargo

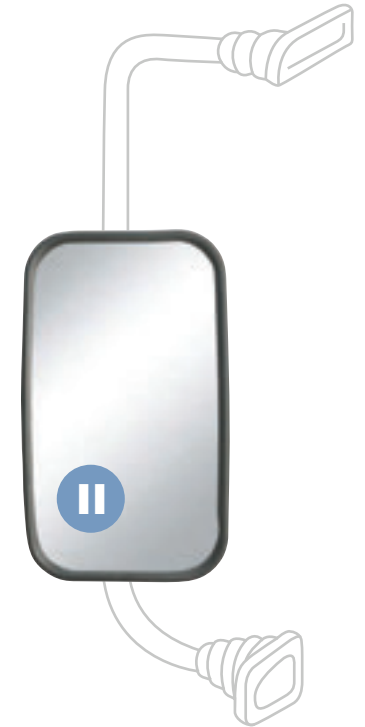

060/500

II

99457908
42344326



IV

IV

E3 022095
240 x 175 mm



V

E3 022091
240 x 175 mm

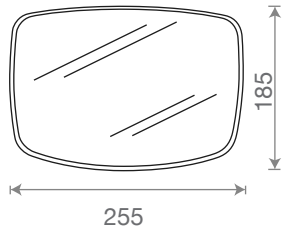

applicabilità:
applicable to:
Verwendbar für

IVECO 060. Eurocargo
IVECO 120. Eurocargo
IVECO 150. Eurocargo



II

060/502

IV

2997216
99457905



S
M
L



S
M
L



IVECO

suitable to

IVECO

applicabilità:
applicable to:
Verwendbar für

IVECO 240. Eurotech
IVECO 440. Eurostar
IVECO 240. Eurotrakker



-
II

-
IV

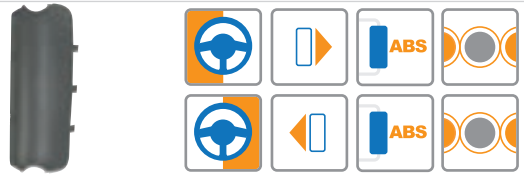
a	-	-		
b	-	-		
	II			
c	-	-		
	IV			
d	060/504	93190977		155x430 mm
	II			
e	-	-		
	IV			
f	-	-		
g	-	-		



suitable to

IVECO

applicabilità:
applicable to:
Verwendbar für

IVECO 060. Eurocargo
IVECO 120. Eurocargo
IVECO 150. Eurocargo
IVECO 240. Eurotech
IVECO 440. Eurostar
IVECO 240. Eurotrakker









-

II

-

IV

a	-	-			
b	-	-			
c	-	-			
d	060/505	93190977		       	155x325 mm
e	-	-			
f	-	-			
g	-	-			



S
M
L



S
M
L



IVECO

COVINO

suitable to

IVECO

applicabilità:
applicable to:
Verwendbar für

IVECO 060. Eurocargo
IVECO 120. Eurocargo
IVECO 150. Eurocargo
IVECO 240. Eurotech
IVECO 440. Eurostar
IVECO 240. Eurotrakker



-
II

-
IV

a - -

b - -

II

c - -

IV

d - -

II

e 440/508-

93193203



160x160 mm

f - -

g - -



S

M

L



S

M

L



IVECO

COVIND

suitable to

IVECO

095/500

5801765364
 (5801580263)
 (5801341207)
 (504150552)
 (504369995)



II

E4 024098
 181x371 mm



IV

E4 024099
 192x206 mm

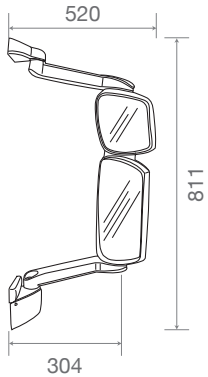

applicabilità:
 applicable to:
 Verwendbar für







IVECO 195. Eurocargo 2015
 IVECO 095. Eurocargo 2008
 IVECO 075. Tector Restyling 04/2006→
 IVECO 225. Eurocargo 2015
 IVECO 135. Eurocargo 2008
 IVECO 125. Tector Restyling 04/2006→
 IVECO 155. Tector Restyling 04/2006→
 ASTRA HD9. Heavy Duty 9

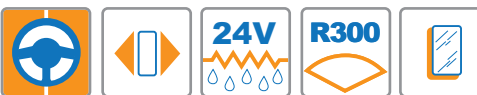

II

IV

095/500

a	-	-			
b	560/509 II	2997667 (504159282) (504197878) (504159284) (504159286)			E4 024098 181x371 mm
c	095/505 IV	2997668 (504197879)			E4 024099 192x206 mm
d	560/504 II	504158975			246x383 mm
e	095/506 IV	504158977			242x230 mm
f	-	-			
g	-	-			



suitable to

IVECO

095/501

5801765363
 (5801580261)
 (5801341206)
 (504150551)
 (504369979)



II

E4 024098

181x371 mm



IV

E4 024099

192x206 mm

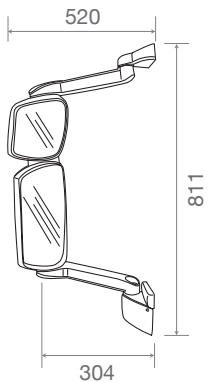

applicabilità:
 applicable to:
 Verwendbar für

IVECO 195. Eurocargo 2015
 IVECO 095. Eurocargo 2008
 IVECO 075. Tector Restyling 04/2006→
 IVECO 225. Eurocargo 2015
 IVECO 135. Eurocargo 2008
 IVECO 125. Tector Restyling 04/2006→
 IVECO 155. Tector Restyling 04/2006→
 ASTRA HD9. Heavy Duty 9



II

IV

095/501

a	-	-			E4 024098 181x371 mm
b	560/509 II	2997667 (504159282) (504197878) (504159284) (504159286)			E4 024098 181x371 mm
c	095/505 IV	2997668 (504197879)			E4 024099 192x206 mm
d	560/505 II	504158974			246x383 mm
e	095/507 IV	504158976			242x230 mm
f	-	-			
g	-	-			



S
M
L



S
M
L



IVECO

suitable to IVECO

095/503

5801765367
(5801580275)



II

E9 001052

185x375 mm



IV

E9 021048

210x190 mm

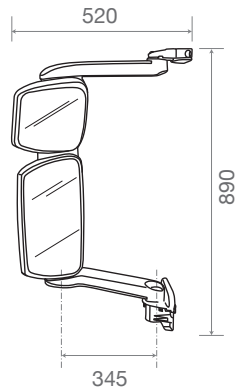

applicabilità:
applicable to:
Verwendbar für



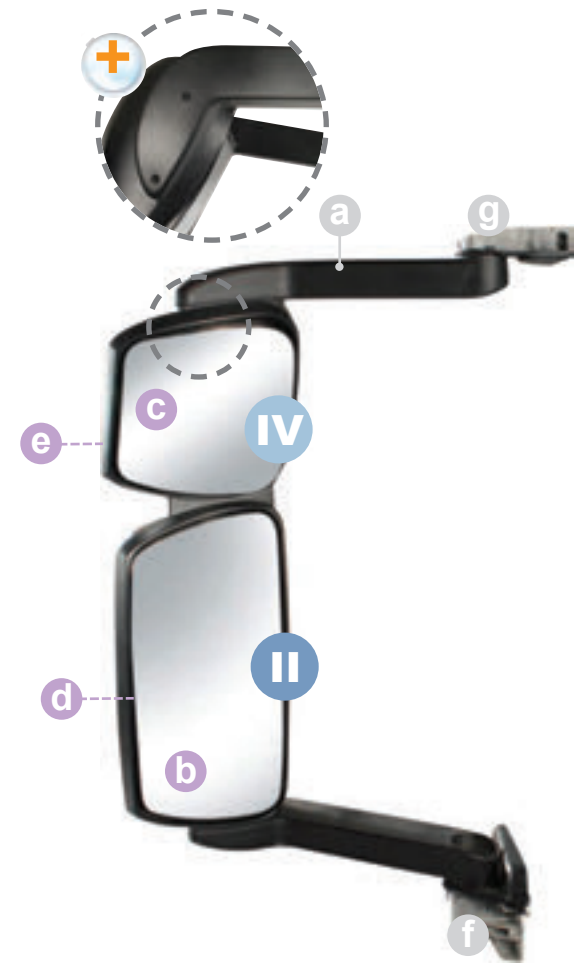

















IVECO 195. Eurocargo 2015
IVECO 095. Eurocargo 2008
IVECO 225. Eurocargo 2015
IVECO 135. Eurocargo 2008



II

IV

095/503

a	-	-			
b	560/509 II	2997667 (504159282) (504197878) (504159284) (504159286)		    	(E9) 024098 181x371 mm
c	095/505 IV	2997668 (504197879)		    	(E4) 024099 192x206 mm
d	560/505 II	504158974		   	246x383 mm
e	095/507 IV	504158976		   	242x230 mm
f	-	-			
g	-	-			



S
M
L



S
M
L



IVECO

suitable to

IVECO

095/510

5802322000
5801806044
504224428



VI



230 x 130 mm

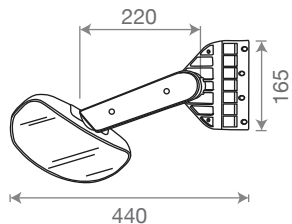

applicabilità:
applicable to:
Verwendbar für

IVECO 195. Eurocargo 2015
IVECO 095. Eurocargo 2008
IVECO 075. Tector Restyling
IVECO 225. Eurocargo 2015
IVECO 135. Eurocargo 2008
IVECO 125. Tector Restyling
IVECO 155. Tector Restyling
IVECO 185. Tector Restyling
IVECO XWY. AD/AT X-Way
IVECO XWY. AS X-Way
IVECO 570. AD/AT Stralis 2013 (HI-ROAD)
IVECO 580. AS Stralis 2013 (HY WAY)
IVECO 550. AD/AT Stralis 2007
IVECO 560. AS Stralis 2007
IVECO 530. AD/AT Stralis
IVECO 540. AS Stralis
IVECO 555. AD/AT Trakker 2007
IVECO 545. AD/AT Trakker (E4)



095/511

5802322008
(58018006057)



VI E9 0411688
230 x 130 mm

applicabilità:
applicable to:
Verwendbar für

IVECO XWY. AD/AT X-Way
IVECO XWY. AS X-Way

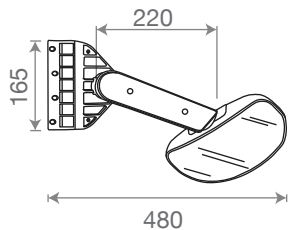

S

M

L



S

M

L



095/520

5801765379
(504168236)



V E3 021051
260 x 160 mm

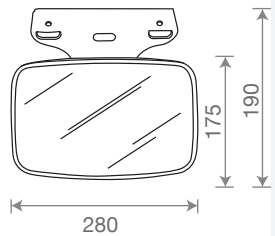

applicabilità:
applicable to:
Verwendbar für

- IVECO 195. Eurocargo 2015
- IVECO 095. Eurocargo 2008
- IVECO 075. Tector Restyling
- IVECO 225. Eurocargo 2015
- IVECO 135. Eurocargo 2008
- IVECO 125. Tector Restyling
- IVECO 155. Tector Restyling
- IVECO 185. Tector Restyling
- IVECO XWY. AD/AT X-Way
- IVECO XWY. AS X-Way
- IVECO 570. AD/AT Stralis 2013 (HI-ROAD)
- IVECO 580. AS Stralis 2013 (HY WAY)
- IVECO 550. AD/AT Stralis 2007
- IVECO 560. AS Stralis 2007
- IVECO 530. AD/AT Stralis
- IVECO 540. AS Stralis
- IVECO 555. AD/AT Trakker 2007
- IVECO 545. AD/AT Trakker (E4)



095/520



S
M
L



S
M
L



095/512

504168244



215 x 195 mm

IVECO

095/508

5801876636
(5802287173)



V (E9) 0411687
280x 185 mm

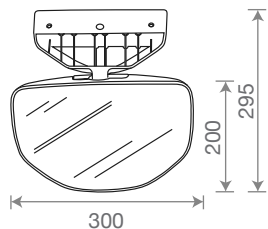

applicabilità:
applicable to:
Verwendbar für

IVECO 195. Eurocargo 2015
IVECO 095. Eurocargo 2008
IVECO 225. Eurocargo 2015
IVECO 135. Eurocargo 2008
IVECO XWY. AD/AT X-Way
IVECO XWY. AS X-Way
IVECO 570. AD/AT Stralis 2013 (HI-ROAD)
IVECO 580. AS Stralis 2013 (HY WAY)
ASTRA HD9. Heavy Duty 9



060/507

98472973
(98472937)
(98472998)

V E3 0146657
250x 155 mm

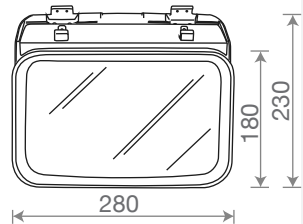

applicabilità:
applicable to:
Verwendbar für

- IVECO 075. Tector Restyling
- IVECO 060. Eurocargo
- IVECO 125. Tector Restyling
- IVECO 155. Tector Restyling
- IVECO 185. Tector Restyling
- IVECO 120. Eurocargo
- IVECO 150. Eurocargo
- IVECO 240. Eurotech
- IVECO 240. Eurotrakker
- IVECO 530. AD/AT Stralis
- IVECO 545. AD/AT Trakker (E4)

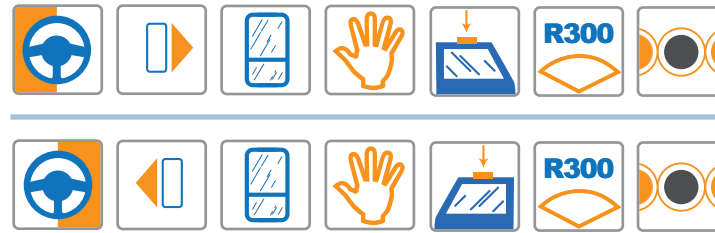

S

M

L



S

M

L





IT Progetto specchi retrovisori. Semistampo per coppa specchio principale in ABS

EN Rear – view mirrors project. Mould for ABS wide-angle cover

DE Rückspiegel-Projekt. Stahlform für ABS Hauptspiegelgehäuse

COVIND



suitable to

MAN

169

suitable to **MAN**

MLX/500

II (E4) 024100
176x379 mm

IV (E4) 024101
167x177 mm

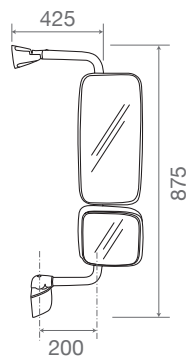

applicabilità:
applicable to:
Verwendbar für

MAN XXL. TGA XXL 12/2006→
MAN XXL. TGA XLX 12/2006→

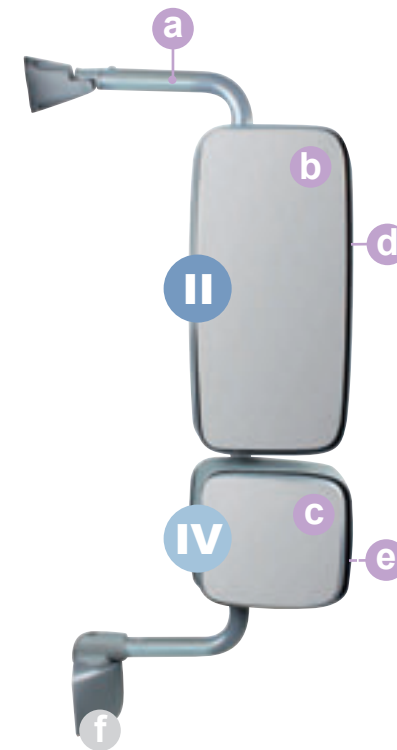

XXL/522

II

81637306481



232x399 mm

XXL/524

IV

81637306513



229x187 mm

MLX/500



S
M
L

a MLX/506

81637316560
(81637316467)



282x275 mm

b XXL/500

81637336049



E4 024100

176x379 mm

c XXL/501

81637336057



E4 024101

177x167 mm

d XXL/506

81637320060
(81637320055)
(81637320064)



215x398 mm

e XXL/502

81637320062
(81637320056)
(81637320066)



215x185 mm

f -

-

suitable to **MAN**

MLX/501

II (E4) 024100
176x379 mm

IV (E4) 024101
177x167 mm

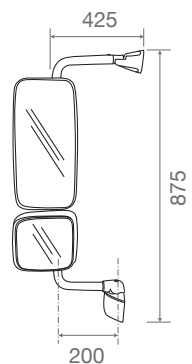

applicabilità:
applicable to:
Verwendbar für

MAN XXL. TGA XXL 12/2006→
MAN XXL. TGA XLX 12/2006→

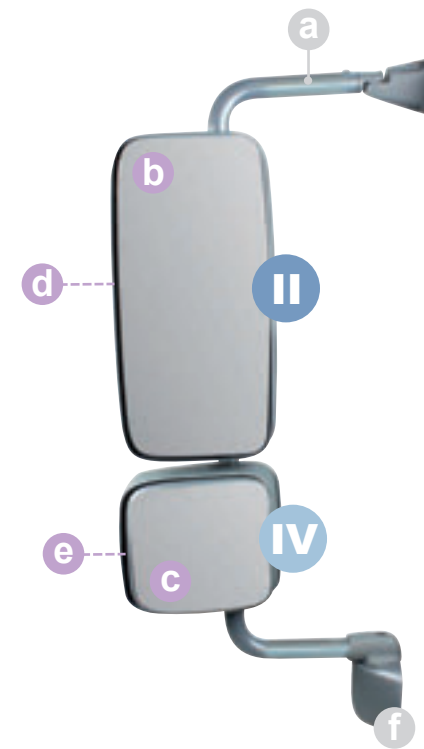

XXL/523

II

81637306480



217x399 mm

XXL/525

IV

81637306512



215x187 mm

MLX/501



S
M
L

a

MLX/507*

81637316557*
(81637316431)*



282x275 mm

b

XXL/500

81637336049

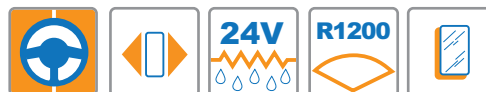

E4 024100

176x379 mm

c

XXL/501

81637336057

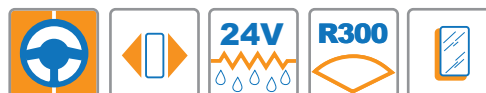

E4 024101

177x167 mm

d

XXL/507

81637320059
(81637320054)
(81637320063)



215x398 mm

e

XXL/503

81637320061
(81637320057)
(81637320065)



215x185 mm

f

-

-

* Non idoneo per il codice MLX/501 (sprovisto di cavo per il collegamento dello specchio ausiliario)
Not suitable for code MLX/501 (does not have the cable for connecting the auxiliary mirror)
Nicht geeignet fuer die Ref.-Nr. MLX/501 (kein Verbindungsleitungskabel fuer die weitwinkelspiegel)



MAN

suitable to **MAN**

TGS/500

81637306762
(81637306550)



II

E4 024102

201x381 mm



IV

E4 024103

197x181 mm

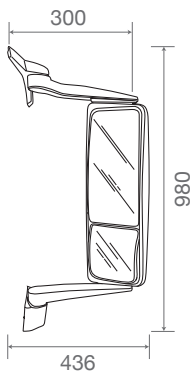

applicabilità:
applicable to:
Verwendbar für

MAN TGS. TGS 09/2007→
MAN TS2. TGS Euro 6

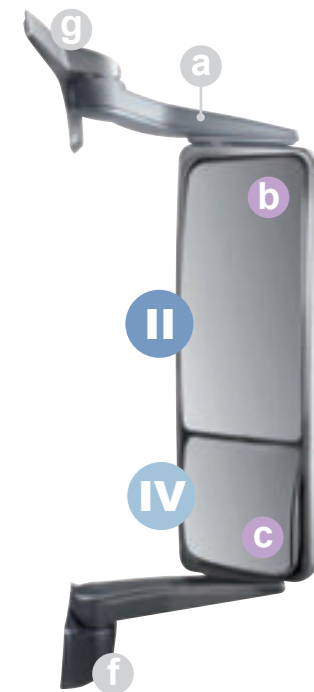

II

IV

TGS/500



S

M

L

a

-

-

b

TGS/502

81637336071



E4 024102

201x381 mm

II

c

TGS/504

81637336072



E4 024103

197x181 mm

IV

f

-

-

g

-

-

COVERING

MAN

suitable to **MAN**

TGS/501

81637306755
(81637306549)



II

E4 024102

201x381 mm



IV

E4 024103

181x197 mm

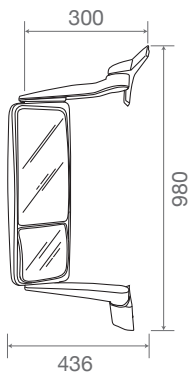

applicabilità:
applicable to:
Verwendbar für

MAN TGS. TGS 09/2007→
MAN TS2. TGS Euro 6

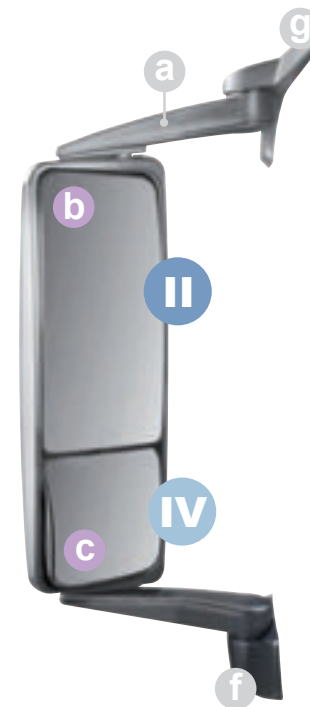

II

IV

TGS/501



S

M

L

a

- -

b

TGS/502

81637336071



E4 024102

201x381 mm

II

c

TGS/505

81637336073



E4 024103

197x181 mm

IV

f

- -

g

- -

COVID

MAN

suitable to **MAN**

TGX/502

81637306765
(81637306561)



II

(E4) 024102

201x381 mm



IV

(E4) 024103

181x197 mm

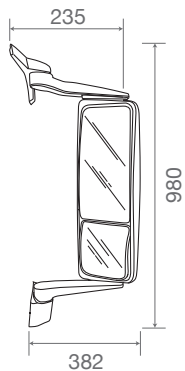

applicabilità:
applicable to:
Verwendbar für

MAN TGX. TGX 09/2007→
MAN TX2. TGX Euro 6

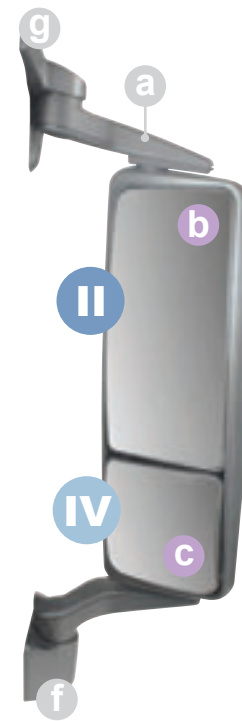

II

IV

TGX/502



S

M

L

a

- -

b

TGS/502

81637336071



E4 024102
201x381 mm

II

c

TGS/504

81637336072



E4 024103
197x181 mm

IV

f

- -

g

- -

COVID

MAN

suitable to **MAN**

TGX/503

81637306756
(81637306560)



II

(E4) 024102

201x381 mm



IV

(E4) 024103

197x181 mm

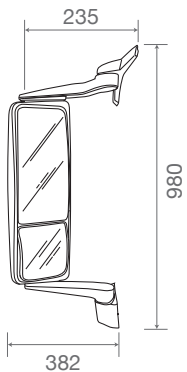

applicabilità:
applicable to:
Verwendbar für

MAN TGX. TGX 09/2007→
MAN TX2. TGX Euro 6



II

IV

TGX/503



S

M

L

a

- -

b

TGS/502

81637336071



E4 024102
201x381 mm

II

c

TGS/505

81637336073



E4 024103
197x181 mm

IV

f

- -

g

- -

COVID

MAN

suitable to **MAN**

XXL/508

II

E4 024100

176x379 mm

IV

E4 024101

167x177 mm

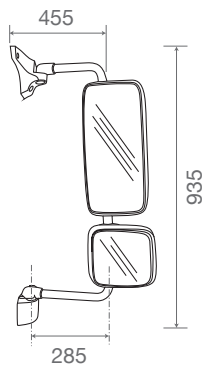

applicabilità:
applicable to:
Verwendbar für

MAN MLX. TGA LX 12/2006→
MAN TGM. TGM 12/2006→11/2014
MAN TGL. TGL 12/2006→11/2014

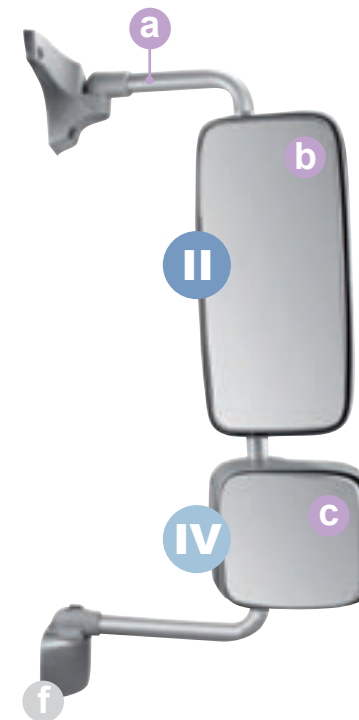

XXL/522

II

81637306481



216x167 mm

XXL/524

IV

81637306513



229x187 mm

XXL/508



S
M
L

a XXL/512

81637316618
(81637316614)



328x935 mm

b XXL/500

81637336049

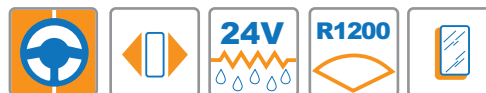

E4 024100
176x379 mm

c XXL/501

81637336057

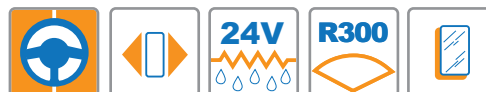

E4 024101
177x167 mm

d XXL/506

81637320060
(81637320055)
(81637320064)



215x398 mm

e XXL/502

81637320062
(81637320056)
(81637320066)



215x398 mm

f -

-

suitable to **MAN**

XXL/509

II

(E4) 024100

176x379 mm

IV

(E4) 024101

177x167 mm

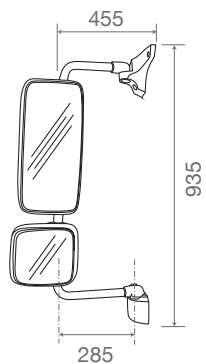

applicabilità:
applicable to:
Verwendbar für

MAN MLX. TGA LX 12/2006→
MAN TGM 12/2006→11/2014
MAN TGL. TGL 12/2006→11/2014

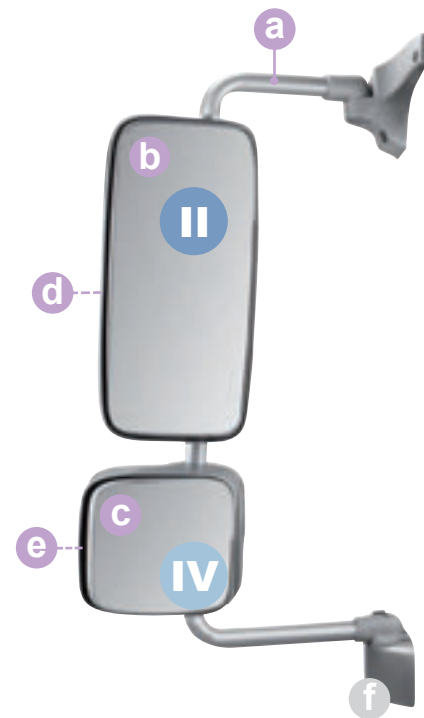

XXL/523

II

81637306480



217x399 mm

XXL/525

IV

81637306512



215x187 mm

XXL/509



S
M
L

a XXL/513

81637316617
(81637316613)



328x935 mm

b XXL/500

81637336049



E4 024100
176x379 mm

c XXL/501

81637336057



E4 024101
177x167 mm

d XXL/507

81637320059
(81637320054)
(81637320063)



215x398 mm

e XXL/503

81637320061
(81637320057)
(81637320065)



215x398 mm

f -

-

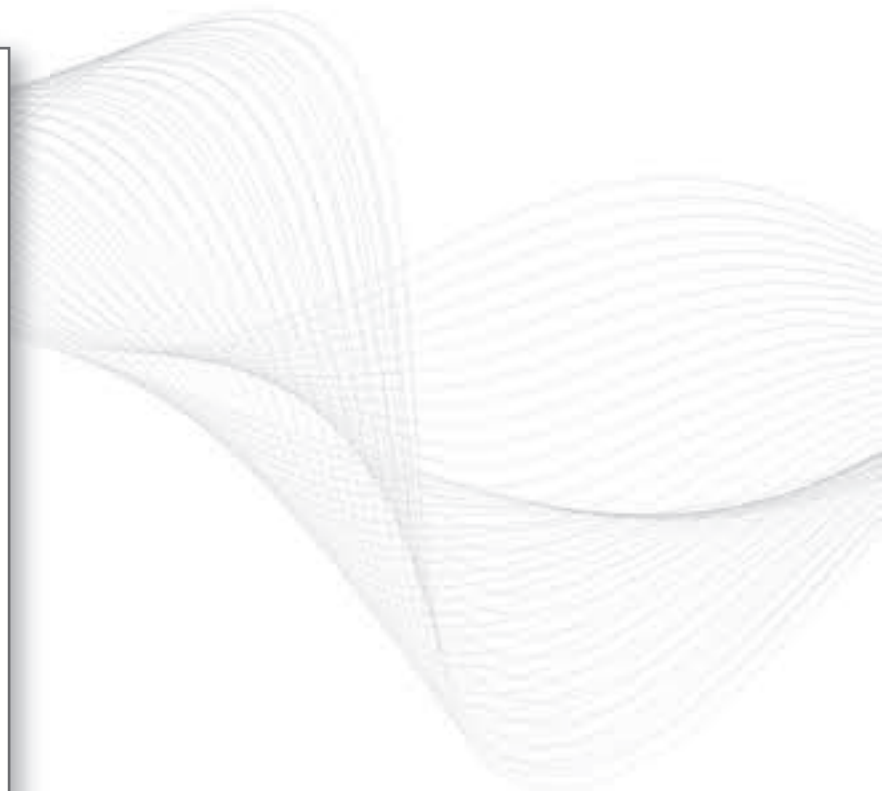
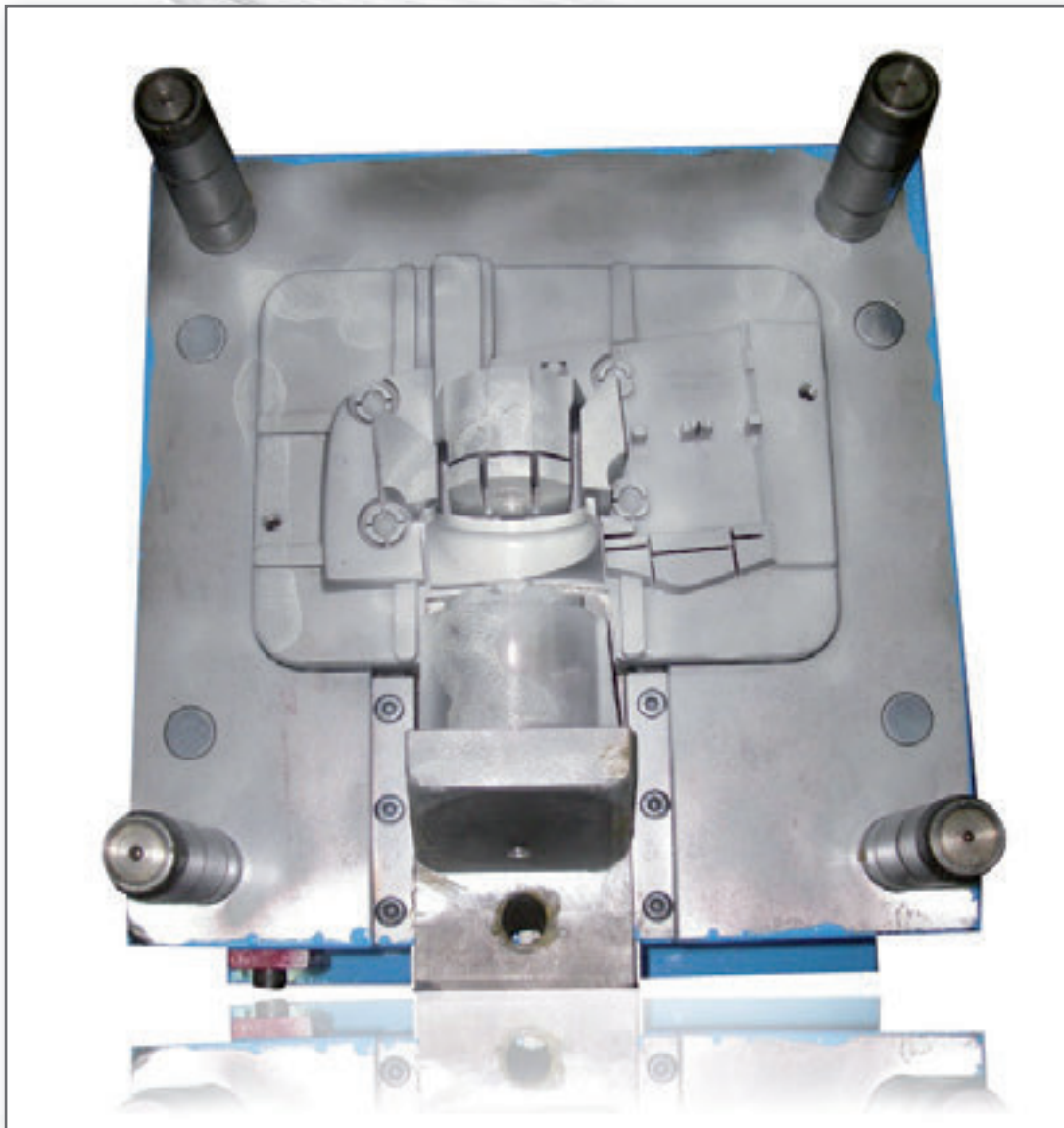

- IT Progetto specchi retrovisori. Stampo per supporto specchio in ABS
EN Rear – view mirrors project. Mould for ABS bracket
DE Rückspiegel-Projekt. Stahlform für ABS Spiegelhalter

COVIND



suitable to **MERCEDES-BENZ**

187

suitable to MERCEDES-BENZ

973/500



II (E4) 024091
170x387 mm



IV (E4) 024090
200x200 mm

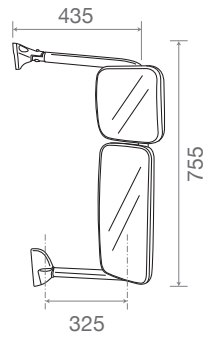

applicabilità:
applicable to:
Verwendbar für

MERCEDES-BENZ 973. Atego I 1998→2004
MERCEDES-BENZ 940. Axor I 2001→2004

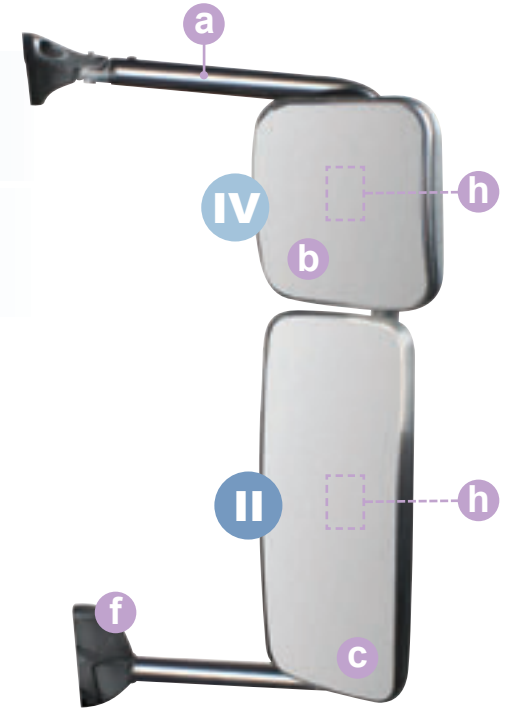

973/511

0008100379
+973/504



170x389 mm

941/508

0018109216



199x199 mm

973/500

a 973/508

9738100414



+ **f**
373x755 mm

b 973/504

0018113433*

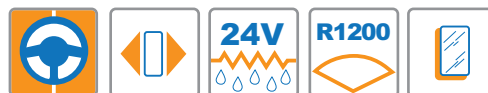

(E4) 024091
170x387 mm

c 941/503

0018116033

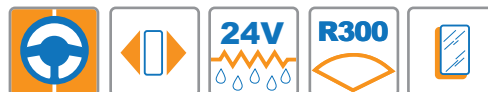

(E4) 024090
200x200 mm

d

II

e

IV

f 973/514

0008110461



h 941/504

0008111307



S

M

L



MERCEDES-BENZ

* OEM R1800_COVIND R1200 // OEM R400_COVIND R300 (view legenda)

suitable to MERCEDES-BENZ

973/501

II

(E4) 024091

170x387 mm

IV

(E4) 024090

200x200 mm

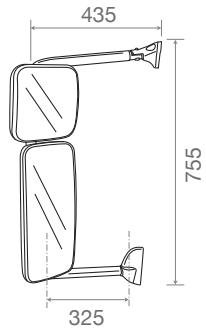

applicabilità:
applicable to:
Verwendbar für

MERCEDES-BENZ 973. Atego I 1998→2004
MERCEDES-BENZ 940. Axor I 2001→2004

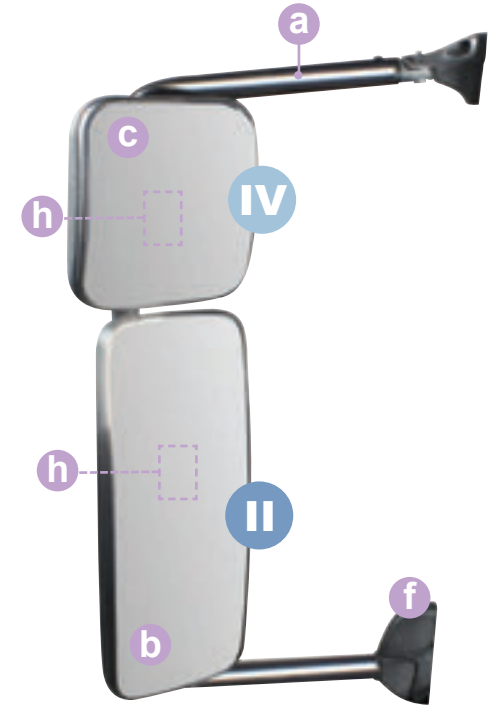

973/511

II

0008100379
+973/504



170x389 mm

941/508

IV

0018109216



199x199 mm

973/501

a 973/509

9738100314



+ **f**
373x755 mm

b 973/504

0018113433*

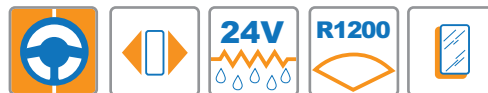

E4 024091
170x387 mm

c 941/503

0018116033

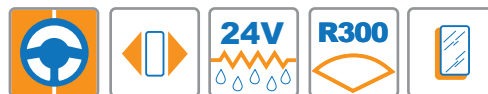

E4 024090
200x200 mm

d

e

f 973/515

0008110361



h 941/504

0008111307



* OEM R1800_COVIND R1200 // OEM R400_COVIND R300 (view legenda)

suitable to MERCEDES-BENZ

973/502

II

E4 024092

180x425 mm

IV

E4 024093

186x192 mm

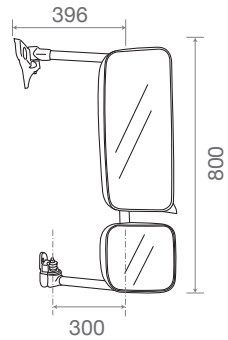

applicabilità:
applicable to:
Verwendbar für

MERCEDES-BENZ 973. Atego II 2004→2013
MERCEDES-BENZ 940. Axor II 2004→2013

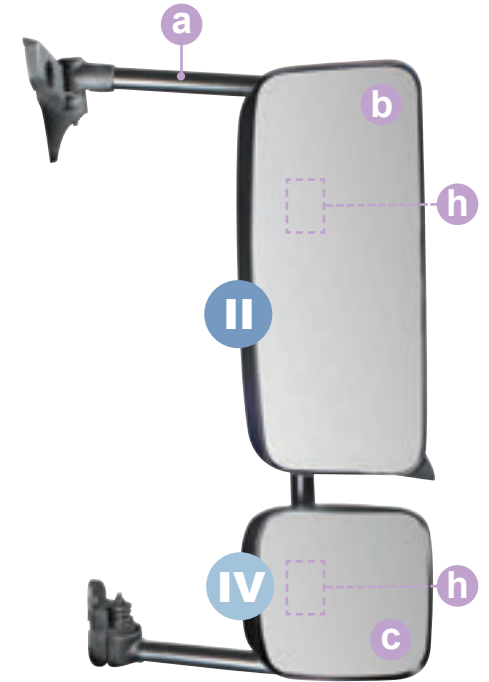

973/516

II

0008102179
(0008101579)
+973/505



215x440 mm

973/518

IV

0008102479
(0008101679)
+973/506



215x198 mm

973/502

a 973/512 0018109814



375x800 mm

b 973/505 0018119933



E4 024092
180x425 mm

c 973/506 0028110033



E4 024093
186x192 mm

d

II

e

IV

f

h 973/507 0008112007



S

M

L



MERCEDES-BENZ

COVIND

suitable to MERCEDES-BENZ

973/503



II (E4) 024092
180x425 mm



IV (E4) 024093
186x192 mm

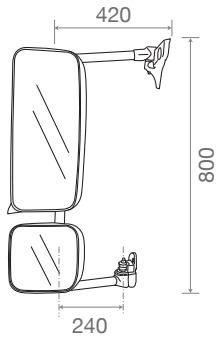

applicabilità:
applicable to:
Verwendbar für

MERCEDES-BENZ 973. Atego II 2004→2013
MERCEDES-BENZ 940. Axor II 2004→2013

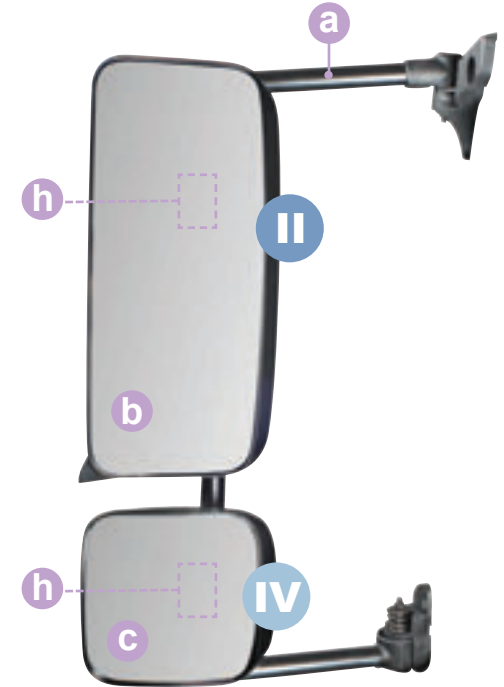

973/517
II

0008102079
(0008101879)
+973/505



216x440 mm

973/518
IV

0008102479
(0008101679)
+973/506



215x198 mm

973/503

a 973/513

0018109714



375x800 mm

b 973/505

0018119933

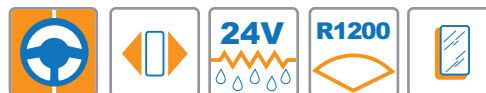

(E4) 024092

180x425 mm

c 973/506

0028110033

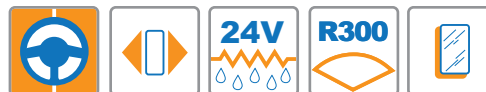

(E4) 024093

186x192 mm

d

II

e

IV

f

h 973/507

0008112007



S

M

L



MERCEDES-BENZ

COVIND

suitable to MERCEDES-BENZ

943/500



II

E4 024089
190x435 mm



IV

E4 024090
200x200 mm

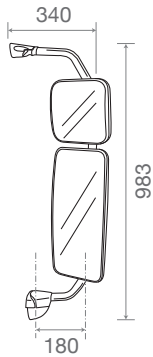

applicabilità:
applicable to:
Verwendbar für

MERCEDES-BENZ 943. Actros II 2004→2007
MERCEDES-BENZ 943. Actros II Mega Space 2004→2007

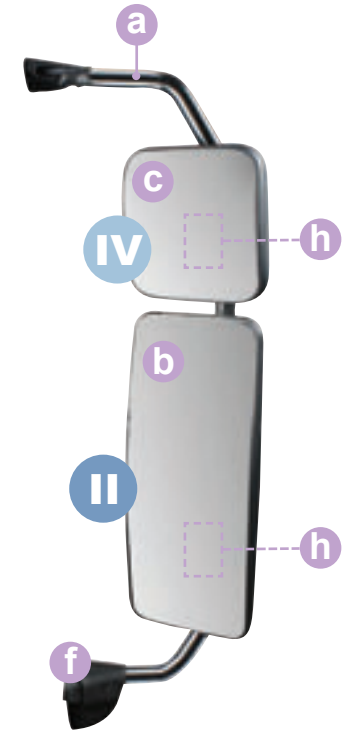

941/509

II

0018109116



190x435 mm

941/508

IV

0018109216



199x199 mm

943/500

a 943/506

0028100914



285x983 mm

b 941/502

0028110433



E4 024089

190x435 mm

c 941/503

0018116033



E4 024090

200x200 mm

d

II

e

IV

f 941/514

9418110007



h 941/504

0008111307



S

M

L



MERCEDES-BENZ

COVIND

suitable to MERCEDES-BENZ

943/501



II

E4 024089

190x435 mm



IV

E4 024090

200x200 mm

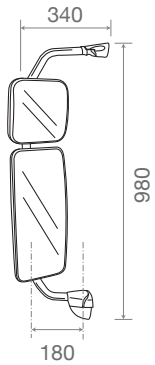

applicabilità:
applicable to:
Verwendbar für

MERCEDES-BENZ 943. Actros II 2004→
MERCEDES-BENZ 943. Actros II Mega Space 2004→

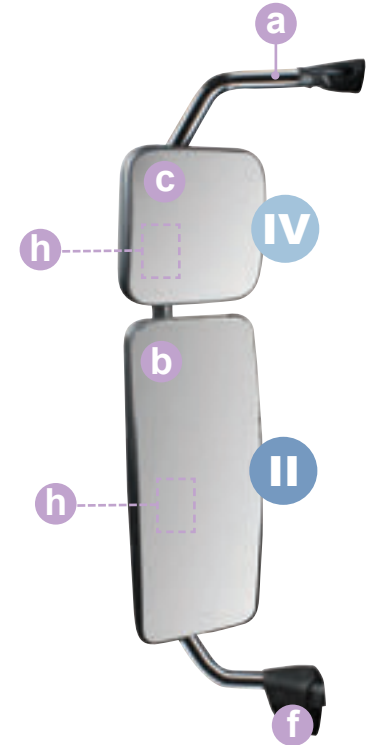

941/509

II

0018109116



190x435 mm

941/508

IV

0018109216



199x199 mm

943/501

a 943/507 0028100814



253x980 mm

b 941/502 0028110433



(E4) 024089

190x435 mm

c 941/503 0018116033

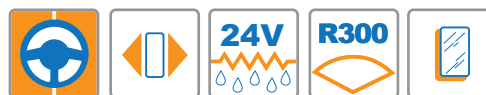

(E4) 024090

200x200 mm

d

e

f 941/514 9418110007



h 941/504 0008111307



S

M

L



MERCEDES-BENZ

COVIND

suitable to MERCEDES-BENZ

943/502

9438106016



II (E32) 040010
200x400 mm



IV (E32) 040011
193x196 mm

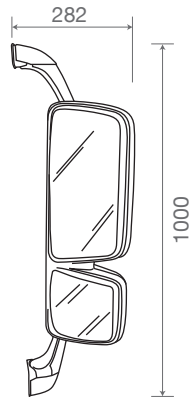

applicabilità:
applicable to:
Verwendbar für

MERCEDES-BENZ 943. Actros III
MERCEDES-BENZ 943. Actros III Mega Space

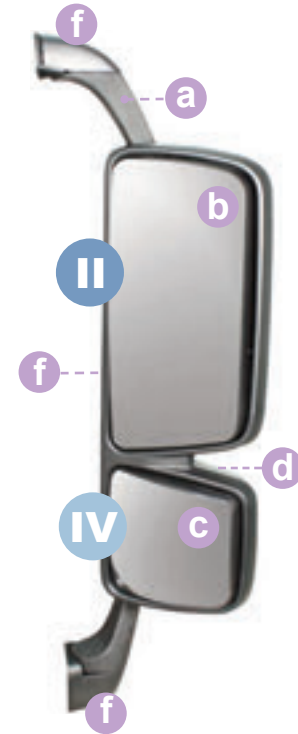

-
II

-
IV

943/502

a 943/526 0028103314



373x755 mm

b 943/496 0028113433



E32 040010
200x400 mm

c 943/492 0028113833



E32 040011
193x196 mm

d 943/504 9438110407



f 943/508 0028102516



f 943/514 9438110207



f 943/513 9438110107



S

M

L



MERCEDES-BENZ

suitable to MERCEDES-BENZ

943/503

9438105816



II

E32 040010

200x400 mm



IV

E32 040011

193x196 mm

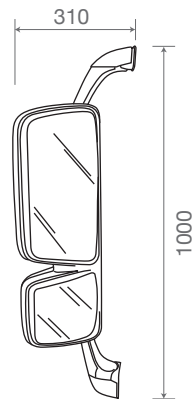

applicabilità:
applicable to:
Verwendbar für

MERCEDES-BENZ 943. Actros III
MERCEDES-BENZ 943. Actros III Mega Space

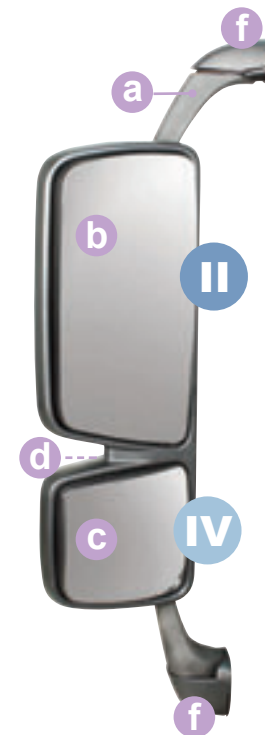

II

IV

943/503

a 943/527 0028103214



373x755 mm

b 943/497 0028113333



E32 040010
200x400 mm

c 943/493 0028113733



E32 040011
193x196 mm

d 943/505 9438110307



f 943/509 0028102416



f 943/514 9438110207



f 943/513 9438110107



S

M

L



MERCEDES-BENZ

suitalia **MERCEDES-BENZ**

941/500

II (E4) 024089
190x435 mm

IV (E4) 024090
200x200 mm

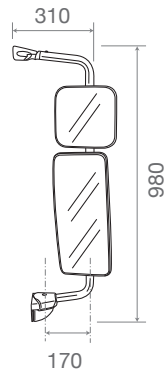

applicabilità:
applicable to:
Verwendbar für

MERCEDES-BENZ 941. Actros I 1996→2004
MERCEDES-BENZ 944. Actros I Mega Space 1996→2004

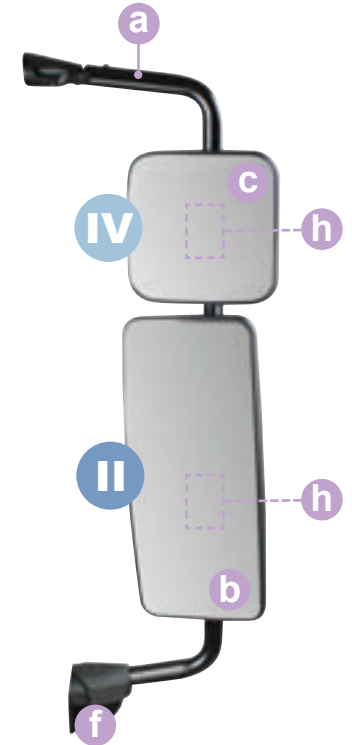

941/509

II

0018109116



190x435 mm

941/508

IV

0018109216



199x199 mm

941/500

a 941/506

0018104514



265x985 mm

b 941/502

0028110433



E4 024089
190x435 mm

c 941/503

0018116033



E4 024090
200x200 mm

d

e

f 941/514

9418110007



h 941/504

0008111307



S

M

L



MERCEDES-BENZ

COVIND

suitable to MERCEDES-BENZ

941/501



E4 024089

190x435 mm



applicabilità:
applicable to:
Verwendbar für

MERCEDES-BENZ 941. Actros I 1996→2004
MERCEDES-BENZ 944. Actros I Mega Space 1996→2004

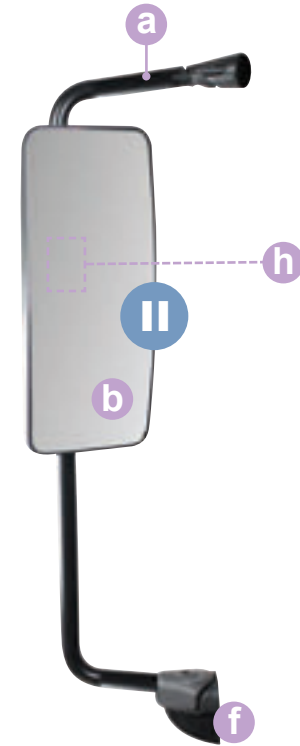
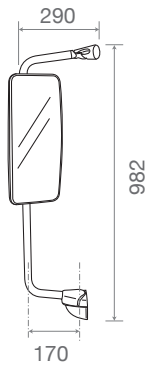

941/509



0018109116



190x435 mm

941/501

a 941/507

0018104414



265x982 mm

b 941/502

0028110433



E4 024089
190x435 mm

c

d

e

f 941/514

9418110007



h 941/504

0008111307



S

M

L



MERCEDES-BENZ

COVID

suitable to MERCEDES-BENZ

940/510

9408107516



VI

E11 026153

225x220 mm

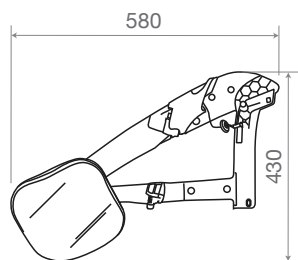

applicabilità:
applicable to:
Verwendbar für

MERCEDES-BENZ 940. Axor I
MERCEDES-BENZ 940. Axor II
MERCEDES-BENZ 973. Atego I
MERCEDES-BENZ 973. Atego II



suitalia **MERCEDES-BENZ**

940/511

9408107316



VI

E11 048600

225x220 mm

650

440

applicabilità:
applicable to:
Verwendbar für

MERCEDES-BENZ 940. Axor I
MERCEDES-BENZ 940. Axor II
MERCEDES-BENZ 973. Atego I
MERCEDES-BENZ 973. Atego II



S

M

L



MERCEDES-BENZ

COVIND

suitable to MERCEDES-BENZ

943/522

9438105116



VI E11 048600
225x220 mm

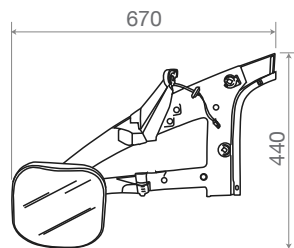

applicabilità:
applicable to:
Verwendbar für

MERCEDES-BENZ 943. Actros II
MERCEDES-BENZ 943. Actros II Mega Space



suitalia **MERCEDES-BENZ**

973/510

0028100816
9408102616

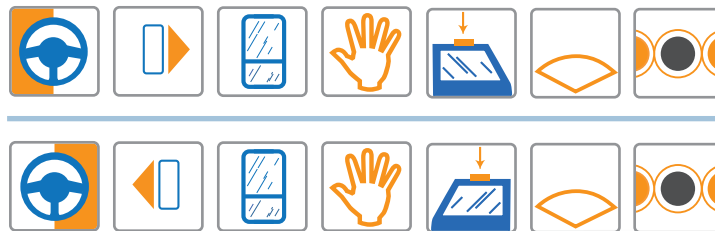

VI E11 026860
280x140 mm

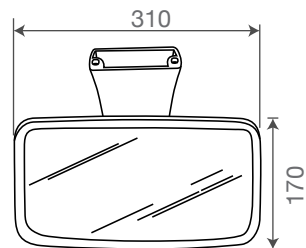

applicabilità:
applicable to:
Verwendbar für

MERCEDES-BENZ 940. Axor I
MERCEDES-BENZ 940. Axor II
MERCEDES-BENZ 973. Atego I
MERCEDES-BENZ 973. Atego II
MERCEDES-BENZ 941. Actros I
MERCEDES-BENZ 944. Actros I Mega Space
MERCEDES-BENZ 943. Actros II
MERCEDES-BENZ 943. Actros II Mega Space



S
M
L



MERCEDES-BENZ

COVIND



IT Progetto specchi retrovisori. Stampo per supporto specchio

EN Rear - view mirrors project. Mould for mirror support

DE Rückspiegel-Projekt. Stahlform für ABS Spiegelhalter

COVIND

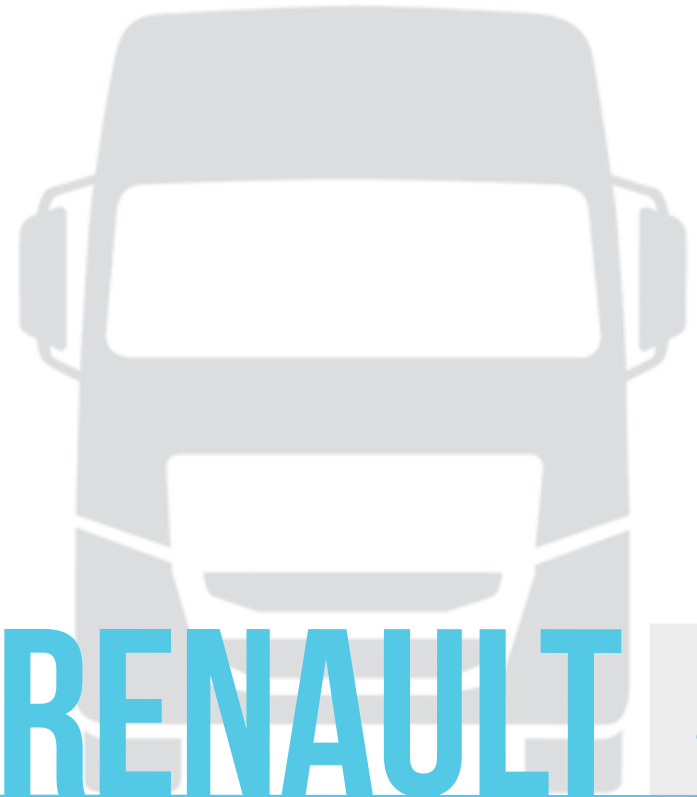

suitable to

RENAULT

213

suitable to RENAULT

LF0/500

5010623232
7421326527



II

E4 024104

202x337 mm



IV

E4 024105

200x197 mm

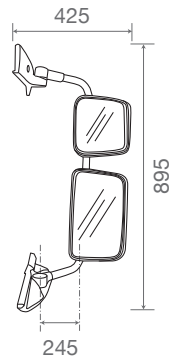

applicabilità:
applicable to:
Verwendbar für

RENAULT Premium Distribution 05/2006→09/2013
RENAULT MDL. Midlum 05/2006→09/2013
RENAULT KER. Kerax 05/2006→09/2013

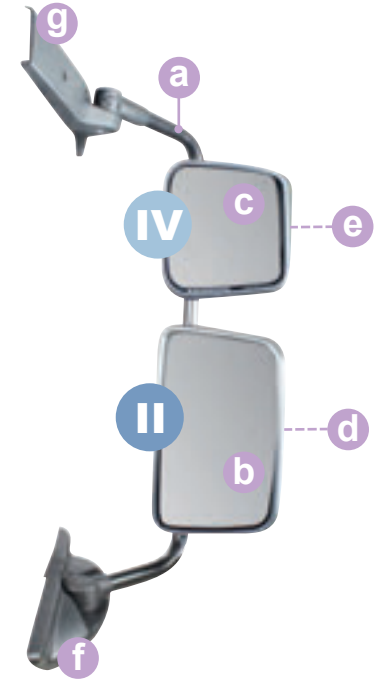

LF0/512

II



244x370 mm

LF0/510

IV



235x243 mm

LF0/500

a PRM/508 7420903727



+ **g**
323x895 mm

b PRM/504 7420862795



E4 024104
202x337 mm

c LF0/504 7420862815



E4 024105
200x197 mm

d LF0/506 7420862779



241x369 mm

e LF0/507 7420862800



235x241 mm

f PRM/512 5010623058



g PRM/522 -



S
M
L

suitable to RENAULT

LF0/501

5010623231



II

E4 024104

202x337 mm



IV

E4 024105

200x197 mm

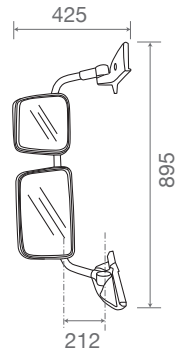

applicabilità:
applicable to:
Verwendbar für

RENAULT Premium Distribution 05/2006→09/2013
RENAULT MDL. Midlum 05/2006→09/2013
RENAULT KER. Kerax 05/2006→09/2013

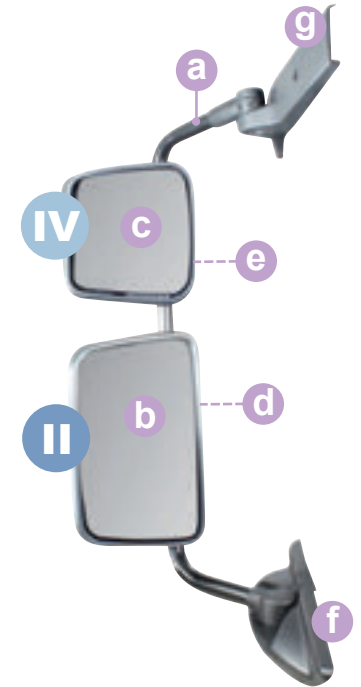

LF0/513

II



241x370 mm

LF0/511

IV



234x245 mm

LF0/501

a PRM/509 7420903722



+ **g**
300x395 mm

b PRM/504 7420862795



E4 024104
202x337 mm

c LF0/505 7420862810



E4 024105
200x197 mm

d LF0/506 7420862779



241x369 mm

e LF0/507 7420862800



235x241 mm

f PRM/513 5010623057



g PRM/523 -



S
M
L

suitable to RENAULT

PRM/500

7421326550
(5010578504)



II (E4) 024104
202x337 mm



IV (E4) 024106
189x203 mm

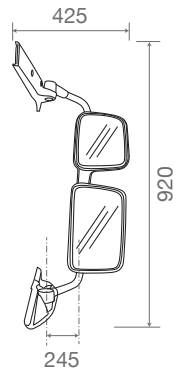

applicabilità:
applicable to:
Verwendbar für

RENAULT PRM. New Premium (Premium Route) 10/2005→09/2013

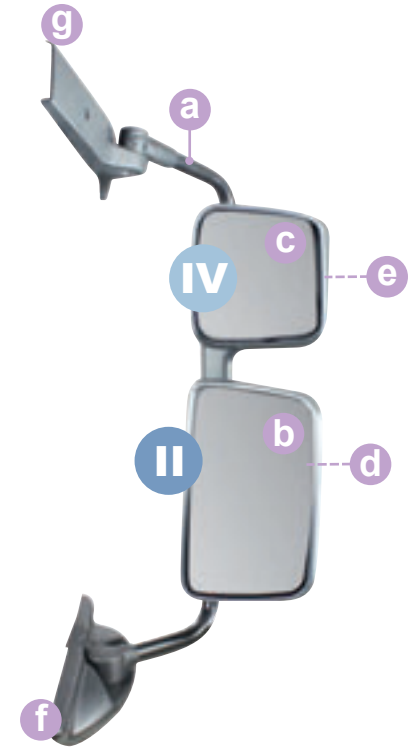

PRM/532
II

-



244x365 mm

PRM/530
IV

-



236x305 mm

PRM/500



S
M
L

a	PRM/508	7420903727			+ g 323x895 mm
b	PRM/504	7420862795			E4 024104 202x337 mm
c	PRM/506	7420903746			E4 024106 189x203 mm
d	PRM/505	7420903880			243x370 mm
e	PRM/502	7420903883			235x305 mm
f	PRM/512	5010623058			
g	PRM/522	-			



RENAULT

RENAULT

PRM/501

5010578503



II

E4 024104

202x337 mm



IV

E4 024106

189x203 mm

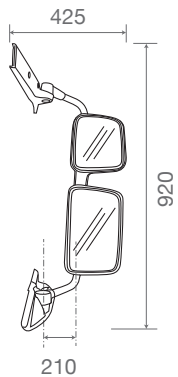

applicabilità:
applicable to:
Verwendbar für

RENAULT PRM. New Premium (Premium Route) 10/2005→09/2013

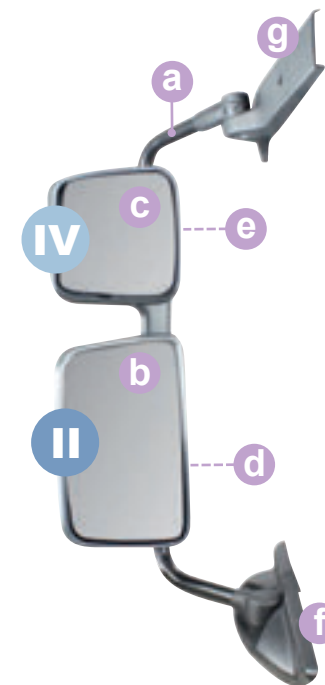

PRM/533

II

-



245x365 mm

PRM/531

IV

-



234x305 mm

PRM/501



S
M
L

a PRM/509 7420903722



+ **g**
300x895 mm

b PRM/504 7420862795

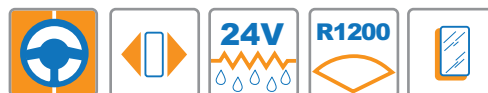

(E4) 024104
202x337 mm

c PRM/507 7420903745



(E4) 024106
189x203 mm

d PRM/505 7420903880



243x370 mm

e PRM/503 7420903882



230x305 mm

f PRM/513 5010623057



g PRM/523 -



COVID

RENAULT

suitable to **RENAULT**

PRM/528

5010578506
7421326551



II

(E4) 024104

202x337 mm



IV

(E4) 024106

189x203 mm

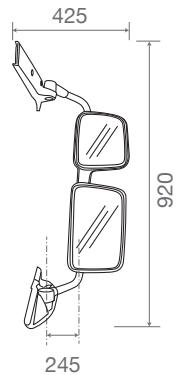

applicabilità:
applicable to:
Verwendbar für

RENAULT PRM. New Premium (Premium Route) 10/2005→09/2013

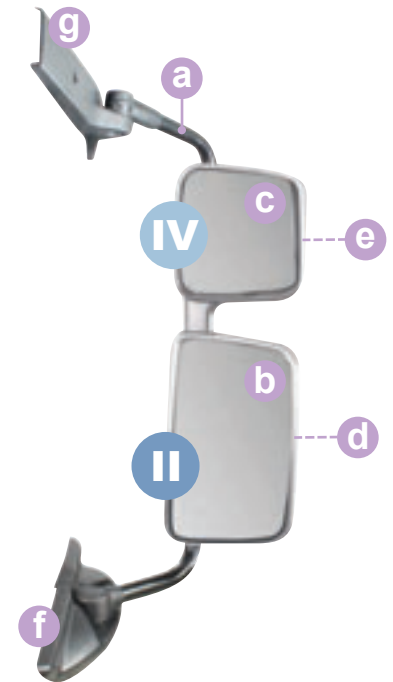

PRM/534

II



245x365 mm

PRM/536

IV



234x305 mm

PRM/528



S
M
L

a PRM/508

7420903727



+ **g**
323x895 mm

b PRM/504

7420862795



E4 024104
202x337 mm

c PRM/506

7420903746



E4 024106
189x203 mm

d PRM/511

7420903881



243x370 mm

e PRM/526

7420903887



235x305 mm

f PRM/512

5010623058



g PRM/522

-



COVID

RENAULT

suitalia **RENAULT**

PRM/529

5010578505



II

E4 024104

202x337 mm



IV

E4 024106

189x203 mm

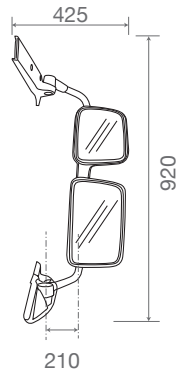

applicabilità:
applicable to:
Verwendbar für

RENAULT PRM. New Premium (Premium Route) 10/2005→09/2013

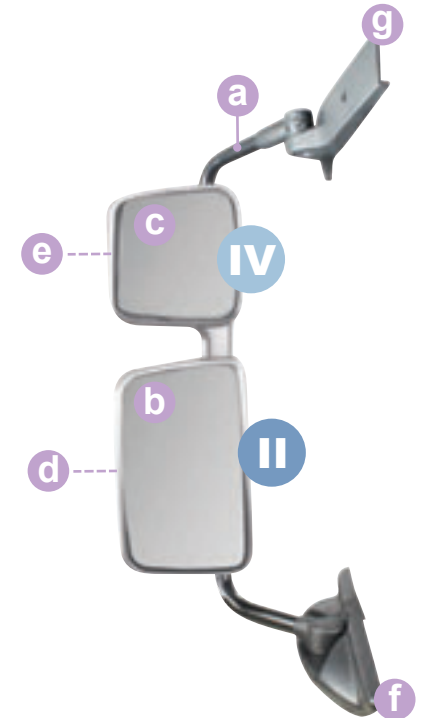

PRM/535

II



245x365 mm

PRM/537

IV



234x305 mm

PRM/529



S
M
L

a	PRM/509	7420903722			+ g 300x895 mm
b	PRM/504	7420862795			E4 024104 202x337 mm
c	PRM/507	7420903745			E4 024106 189x203 mm
d	PRM/511	7420903881			243x370 mm
e	PRM/527	7420903885			230x305 mm
f	PRM/513	5010623057			
g	PRM/523	-			



RENAULT

suitable to RENAULT

LF0/502

5010623247
7421326526



II

E4 024104

200x337 mm



IV

E4 024105

200x197 mm

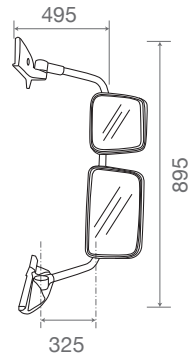

applicabilità:
applicable to:
Verwendbar für

RENAULT Premium Distribution 05/2006→09/2013
RENAULT MDL. Midlum 05/2006→09/2013
RENAULT KER. Kerax 05/2006→09/2013

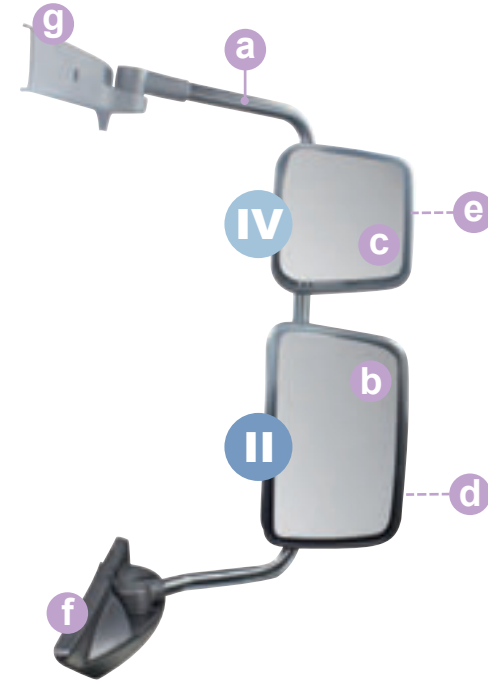

LF0/512

II



244x370 mm

LF0/510

IV



235x243 mm

LF0/502



S
M
L

<p>a LF0/508</p>	<p>7420903732</p>			<p>+ g 387x895 mm</p>
<p>b PRM/504</p> <p>II</p>	<p>7420862795</p>			<p>E4 024104 202x337 mm</p>
<p>c LF0/504</p> <p>IV</p>	<p>7420862815</p>			<p>E4 024105 200x197 mm</p>
<p>d LF0/506</p> <p>II</p>	<p>7420862779</p>			<p>241x369 mm</p>
<p>e LF0/507</p> <p>IV</p>	<p>7420862800</p>			<p>235x241 mm</p>
<p>f PRM/512</p>	<p>5010623058</p>			
<p>g PRM/522</p>	<p>-</p>			

COVID

RENAULT

suitalia **RENAULT**

LF0/503

5010623246



II

E4 024104

202x337 mm



IV

E4 024105

200x197 mm

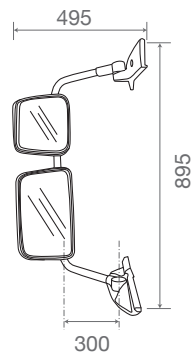

applicabilità:
applicable to:
Verwendbar für

RENAULT Premium Distribution 05/2006→09/2013
RENAULT MDL. Midlum 05/2006→09/2013
RENAULT KER. Kerax 05/2006→09/2013

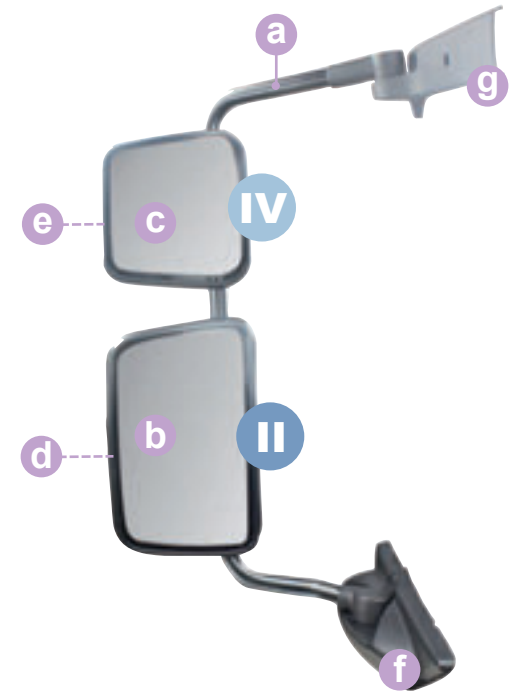

LF0/513

II



241x370 mm















LF0/511

IV



234x245 mm

LF0/503

<p>a LF0/509</p>	<p>7420903723</p>			<p>+ g 387x895 mm</p>
<p>b PRM/504 II</p>	<p>7420862795</p>			<p>E4 024104 202x337 mm</p>
<p>c LF0/505 IV</p>	<p>7420862810</p>			<p>E4 024105 200x197 mm</p>
<p>d LF0/506 II</p>	<p>7420862779</p>			<p>241x369 mm</p>
<p>e LF0/507 IV</p>	<p>7420862800</p>			<p>235x241 mm</p>
<p>f PRM/513</p>	<p>5010623057</p>			
<p>g PRM/523</p>	<p>-</p>			



S
M
L

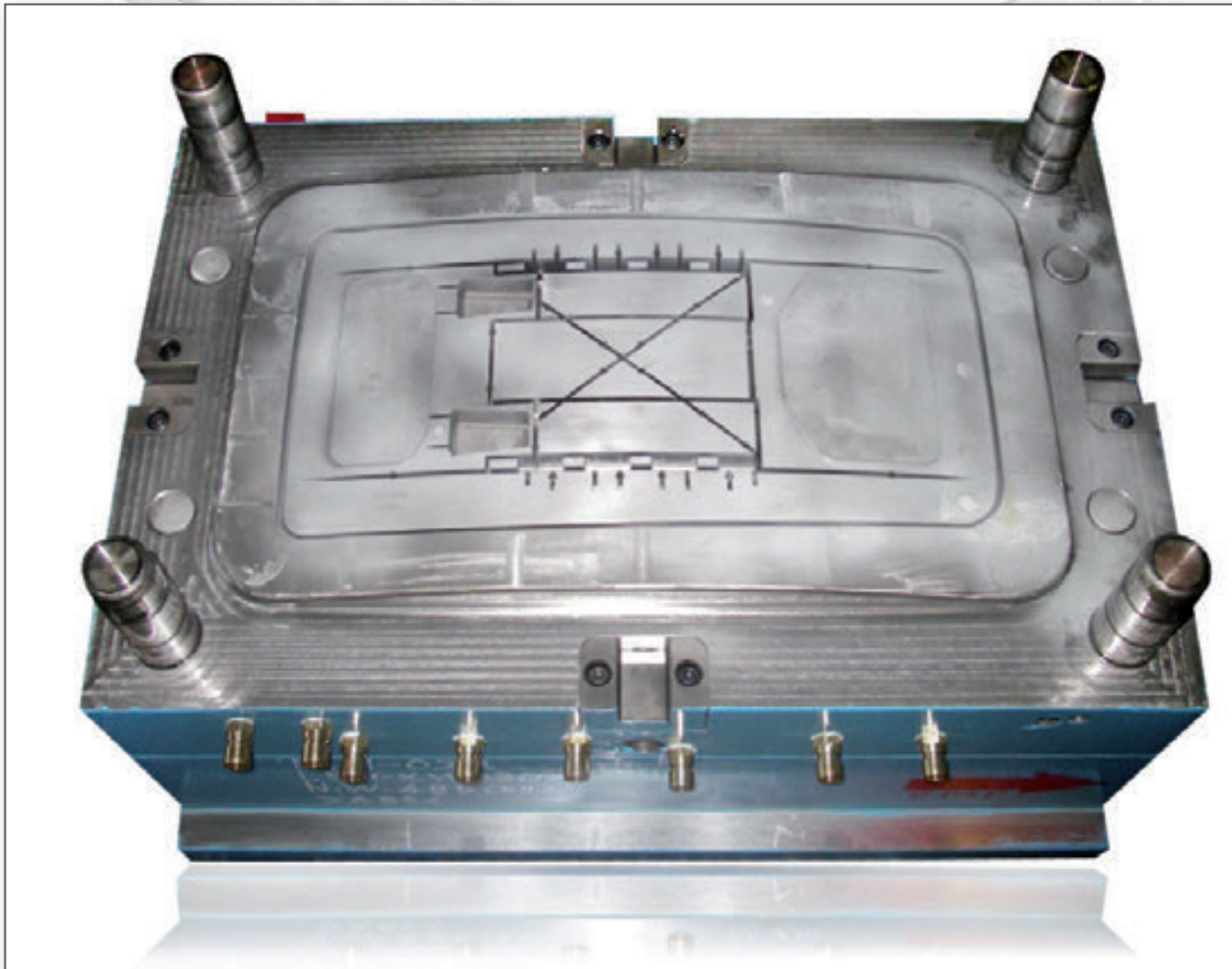

- IT Progetto specchi retrovisori. Stampo per supporto specchio
EN Rear - view mirrors project. Mould for mirror support
DE Rückspiegel-Projekt. Stahlform für ABS Spiegelhalter

COVIND



suitable to

SCANIA

231

suitable to **SCANIA**

144/503

II (E4) 024107
200x432 mm

IV

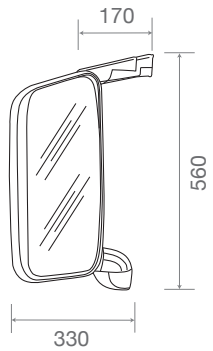

applicabilità:
applicable to:
Verwendbar für



SCANIA 146. Serie R 2010 CP
 SCANIA 146. Serie R 2010 CG-CR
 SCANIA SCP. Serie R CP 2004→
 SCANIA SCR. Serie R CG-CR 2004→
 SCANIA 94. Serie 4 CP 1996→2004
 SCANIA 144. SERIE 4 CG-CR 1996→2004



II

IV

144/503

a

- -

b

144/501

1765985



E4 024107
200x432 mm

d

- -

f

144/512

1346380



S

M

L

SCANIA

COVIND

suitable to **SCANIA**

144/508



II

E4 024107

200x432 mm



IV

E4 024108

184x160 mm



applicabilità:
applicable to:
Verwendbar für

SCANIA 146. Serie R 2010 CP
SCANIA 146. Serie R 2010 CG-CR
SCANIA SCP. Serie R CP 2004→
SCANIA SCR. Serie R CG-CR 2004→
SCANIA 94. Serie 4 CP 1996→2004
SCANIA 144. SERIE 4 CG-CR 1996→2004

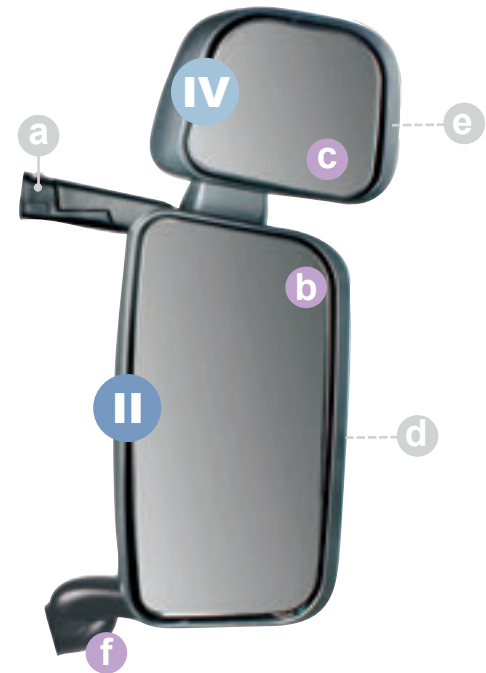
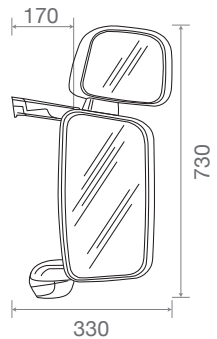

II

144/510

1765808



260x348 mm

IV

144/508



S
M
L

a

- -

b

144/501

1765985



E4 024107

200x432 mm

II

c

144/502

1767265



E4 024108

184x160 mm

IV

d

- -

e

- -

f

144/512

1346380



suitable to **SCANIA**

144/509

II

(E4) 024107

200x432 mm

IV

(E4) 024108

184x160 mm



applicabilità:
applicable to:
Verwendbar für

SCANIA 146. Serie R 2010 CP
SCANIA 146. Serie R 2010 CG-CR
SCANIA SCP. Serie R CP 2004→
SCANIA SCR. Serie R CG-CR 2004→
SCANIA 94. Serie 4 CP 1996→2004
SCANIA 144. SERIE 4 CG-CR 1996→2004

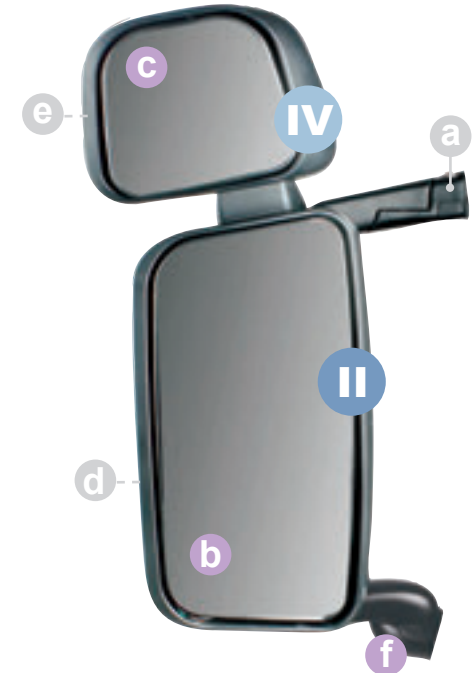
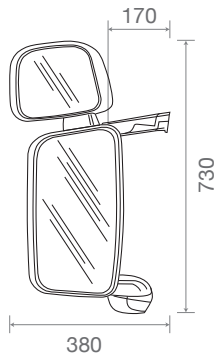

II

144/511

1765809



260x348 mm

IV

144/509



S

M

L

a

-

-

b

144/501

1765985



E4 024107
200x432 mm

II

c

144/502

1767265



E4 024108
184x160 mm

IV

d

-

-

e

-

-

f

144/512

1346380



COVIND

suitable to **SCANIA**

144/505

2425815
(1723518)



II

E4 024107

200x432 mm



IV

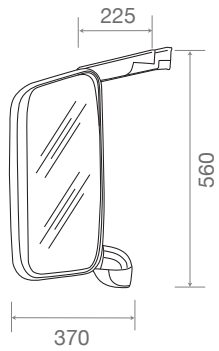

applicabilità:
applicable to:
Verwendbar für

- SCANIA 146. Serie R 2010 CP
- SCANIA 146. Serie R 2010 CG-CR
- SCANIA SCP. Serie R CP 2004→
- SCANIA SCR. Serie R CG-CR 2004→
- SCANIA 94. Serie 4 CP 1996→2004
- SCANIA 144. SERIE 4 CG-CR 1996→2004



II

IV

144/505

a

- -

b

144/501

1765985



E4 024107

200x432 mm

d

- -

f

144/512

1346380



S

M

L

SCANIA

COVIND

suitable to **SCANIA**

144/506

2425816
(1723519)



II

E4 024107

200x432 mm



IV

E4 024108

160x184 mm

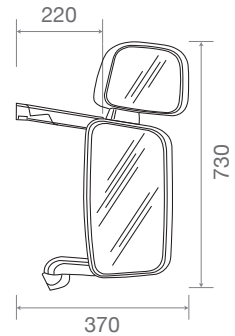

applicabilità:
applicable to:
Verwendbar für

SCANIA 146. Serie R 2010 CP
SCANIA 146. Serie R 2010 CG-CR
SCANIA SCP. Serie R CP 2004→
SCANIA SCR. Serie R CG-CR 2004→
SCANIA 94. Serie 4 CP 1996→2004
SCANIA 144. SERIE 4 CG-CR 1996→2004

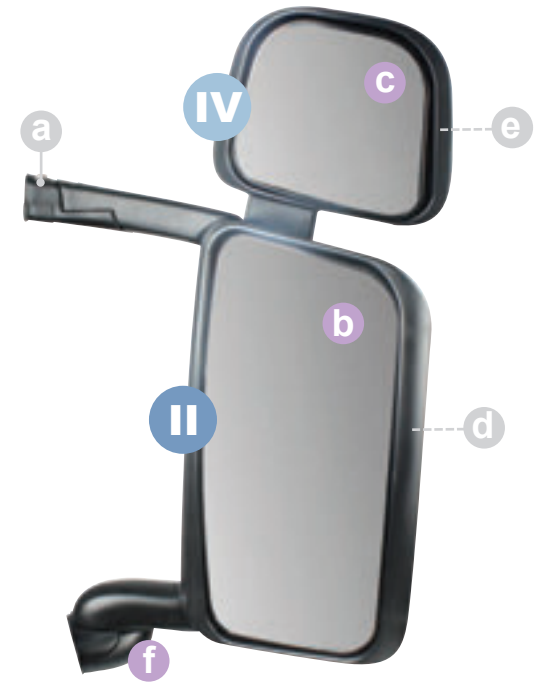

II

144/510

1765808



260x348 mm

IV

240 . adattabile a :: suitable to :: assend an IVECO

144/506



S
M
L

a

- -

b

144/501

1765985



E4 024107

200x432 mm

II

c

144/502

1767265



E4 024108

160x184 mm

IV

d

- -

e

- -

f

144/512

1346380



suitable to **SCANIA**

144/507



II

E4 024107

200x432 mm



IV

E4 024108

184x160 mm



applicabilità:
applicable to:
Verwendbar für

SCANIA 146. Serie R 2010 CP
SCANIA 146. Serie R 2010 CG-CR
SCANIA SCP. Serie R CP 2004→
SCANIA SCR. Serie R CG-CR 2004→
SCANIA 94. Serie 4 CP 1996→2004
SCANIA 144. SERIE 4 CG-CR 1996→2004

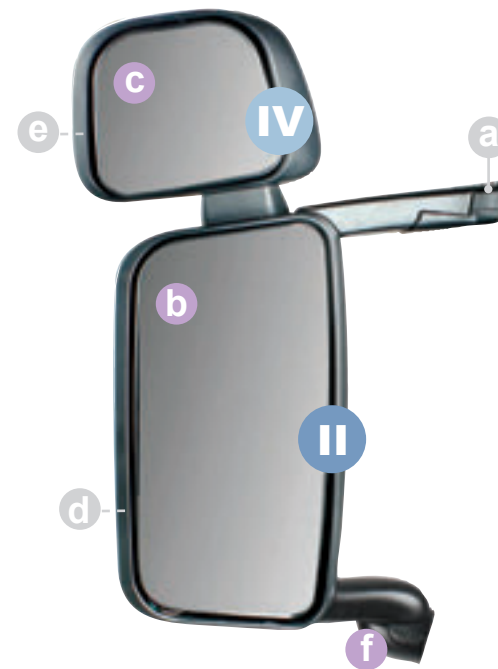
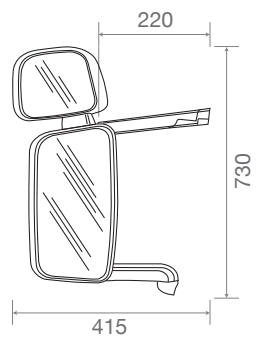

II

144/511

1765809



260x348 mm

IV

144/507



S
M
L

a

- -

b

144/501

1765985



E4 024107
200x432 mm

II

c

144/502

1767265



E4 024108
184x160 mm

IV

d

- -

e

- -

f

144/512

1346380



COVIND

SCANIA

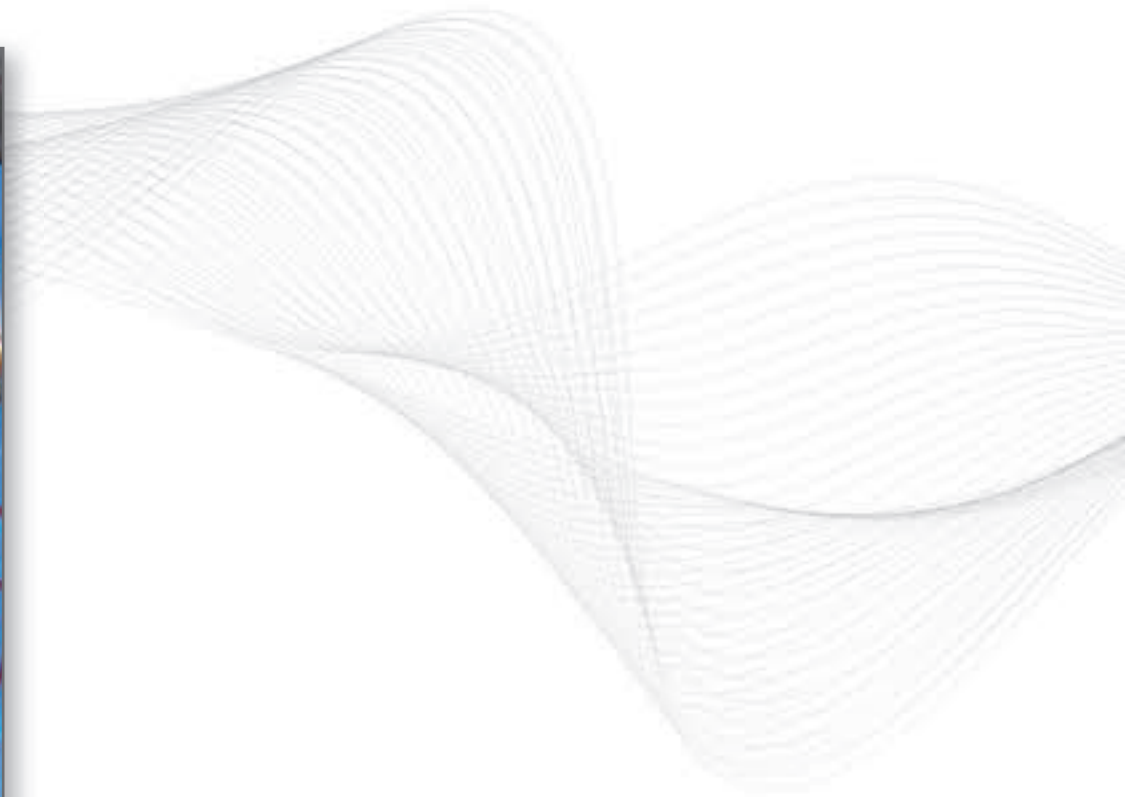

- IT Progetto specchi retrovisori. Stampo per supporto inferiore in ABS
EN Rear – view mirrors project. Mould for ABS lower bracket
DE Rückspiegel-Projekt. Stahlform für ABS untere Armabdeckung

COVIND



suitable to

VOLVO

245

suitable to

VOLVO

LF0/500

21326527
20743983



II

E4 024104

202x337 mm



IV

E4 024105

200x197 mm

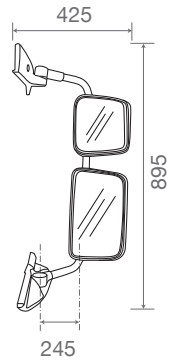

applicabilità:
applicable to:
Verwendbar für

VOLVO 0FE. FE 09/2006→
VOLVO 0FL. FL 09/2006→

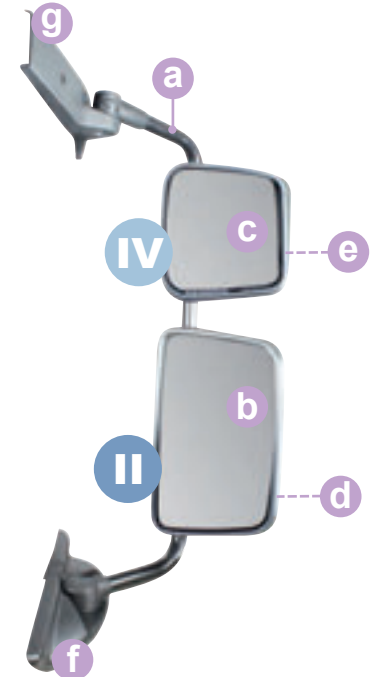

LF0/512

II



244x370 mm















LF0/510

IV



235x243 mm

LF0/500

a PRM/508	20903727			+ g 323x895 mm
b PRM/504 II	20862795			E4 024104 202x337 mm
c LF0/504 IV	20862815			E4 024105 200x197 mm
d LF0/506 II	20862779			241x369 mm
e LF0/507 IV	20862800			235x241 mm
f PRM/512	20708230			
g PRM/522	-			



S

M

L

VOLVO

COVIND

suitable to **VOLVO**

LF0/501

20707881



II

E4 024104

202x337 mm



IV

E4 024105

200x197 mm

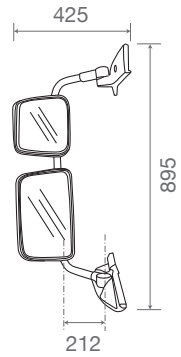

applicabilità:
applicable to:
Verwendbar für

VOLVO OFE. FE 09/2006→
VOLVO OFL. FL 09/2006→

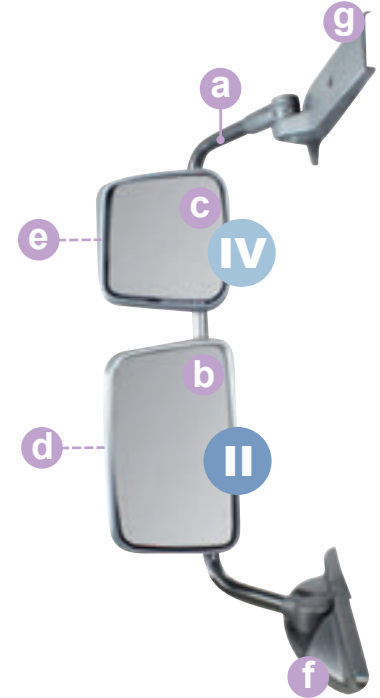

LF0/513

II



241x370 mm

LF0/511

IV



234x245 mm

LF0/501



a PRM/509 20903722



+ **g**
300x895 mm

b PRM/504 20862795



E4 024104
202x337 mm

c LF0/505 20862810



E4 024105
200x197 mm

d LF0/506 20862779



241x369 mm

e LF0/507 20862800



235x241 mm

f PRM/513 20708110



g PRM/523 -

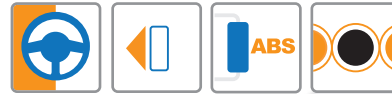

S
M
L

suitable to **VOLVO**

3FH/502

II (E4) 024111
200x435 mm

IV (E4) 024112
176x188 mm

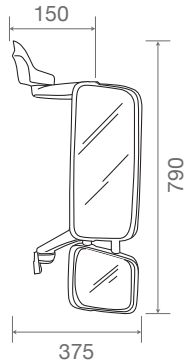

applicabilità:
applicable to:
Verwendbar für

VOLVO 2FH. FH II 2002→
VOLVO 2FM. FM II 2002→



II

2FH/500

IV



249x231 mm

250 . adattabile a :: suitable to :: assend an VOLVO

3FH/502



S

M

L

a

-

b

2FH/503

21320404
(20589788)



E4 024111
200x435 mm

II

c

2FH/504

21320300
(20567685)
(20455995)



E4 024112
176x188 mm

IV

d

2FH/502

20746401
(20360810)



187x435 mm

II

e

2FH/508

20360811



250x200 mm

IV

suitable to VOLVO

3FH/503

II (E4) 024111
200x435 mm

IV (E4) 024112
176x188 mm

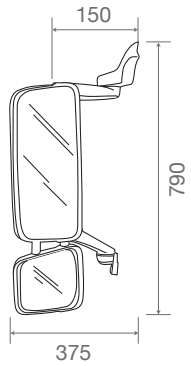

applicabilità:
applicable to:
Verwendbar für

VOLVO 2FH. FH II 2002→
VOLVO 2FM. FM II 2002→

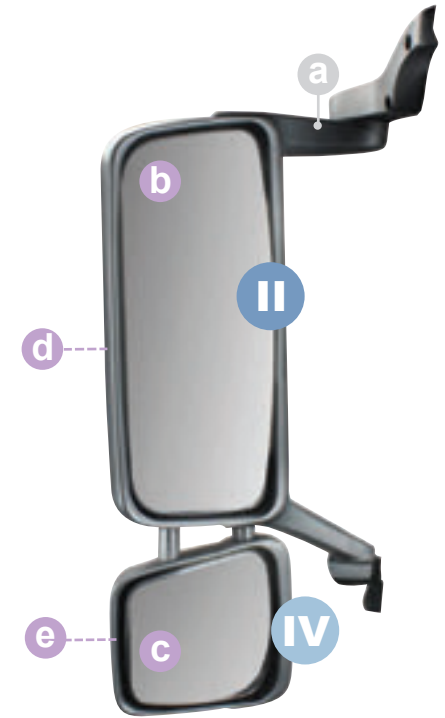

II

2FH/501

IV



250x235 mm

3FH/503



S

M

L

a

- -

b

2FH/503

21320404
(20589788)



E4 024111

200x435 mm

II

c

2FH/504

21320300
(20567685)
(20455995)



E4 024112

176x188 mm

IV

d

2FH/502

20746401
(20360810)



187x435 mm

II

e

2FH/508

20360811



250x200 mm

IV

suitable to **VOLVO**

0FH/508



II

E4 024109

198x433 mm



IV

E4 024110

181x175 mm



applicabilità:
applicable to:
Verwendbar für

VOLVO 0FH. FH 1993→2002
VOLVO 0FM. FM 1998→2002

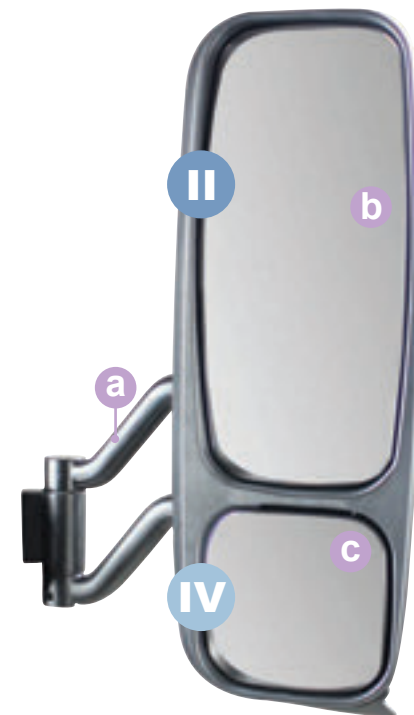
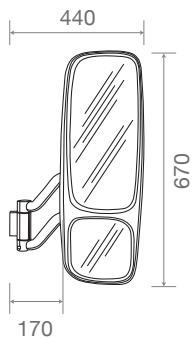

II

IV

OFH/508

a OFH/512 3091751



240x250 mm

b OFH/506 20854564
(3092854)



E4 024109
198x433 mm

c OFH/507 21203311



E4 024110
181x175 mm



S

M

L

suitable to **VOLVO**

0FH/509



II

E4 024109

198x433 mm



IV

E4 024110

181x175 mm

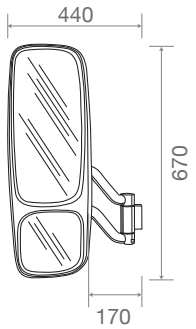

applicabilità:
applicable to:
Verwendbar für

VOLVO 0FH. FH 1993→2002
VOLVO 0FM. FM 1998→2002



II

IV

OFH/509



a OFH/513

3091750



240x250 mm

b OFH/506

20854564
(3092854)



E4 024109
198x433 mm

c OFH/507

21203311



E4 024110
181x175 mm

S

M

L

suitable to **VOLVO**

LF0/502

21475603
20708303



II

(E4) 024104

202x337 mm



IV

(E4) 024105

200x197 mm

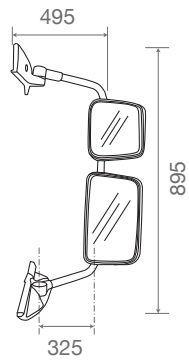

applicabilità:
applicable to:
Verwendbar für

VOLVO OFE. FE 09/2006→
VOLVO OFL. FL 09/2006→

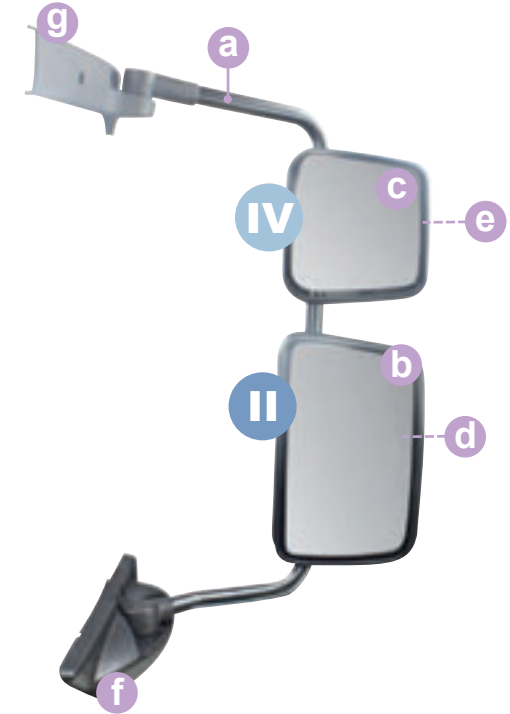

LF0/512

II

-



244x370 mm

LF0/510











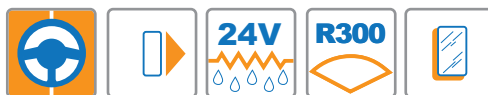

IV

-

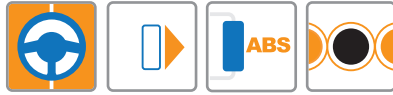

235x243 mm

LF0/502

<p>a LF0/508</p>	<p>20903732</p>			<p>+ g 387x895 mm</p>
<p>b PRM/504</p> <p>II</p>	<p>20862795</p>			<p>(E4) 024104 202x337 mm</p>
<p>c LF0/504</p> <p>IV</p>	<p>20862815</p>			<p>(E4) 024105 200x197 mm</p>
<p>d LF0/506</p> <p>II</p>	<p>20862779</p>			<p>241x369 mm</p>
<p>e LF0/507</p> <p>IV</p>	<p>20862800</p>			<p>235x241 mm</p>
<p>f PRM/512</p>	<p>20708230</p>			
<p>g PRM/522</p>	<p>-</p>			



S
M
L

VOLVO

COVIND

suitable to **VOLVO**

LF0/503

20707874



II

E4 024104

202x337 mm



IV

E4 024105

200x197 mm

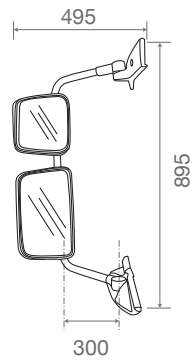

applicabilità:
applicable to:
Verwendbar für

VOLVO OFE. FE 09/2006→
VOLVO OFL. FL 09/2006→

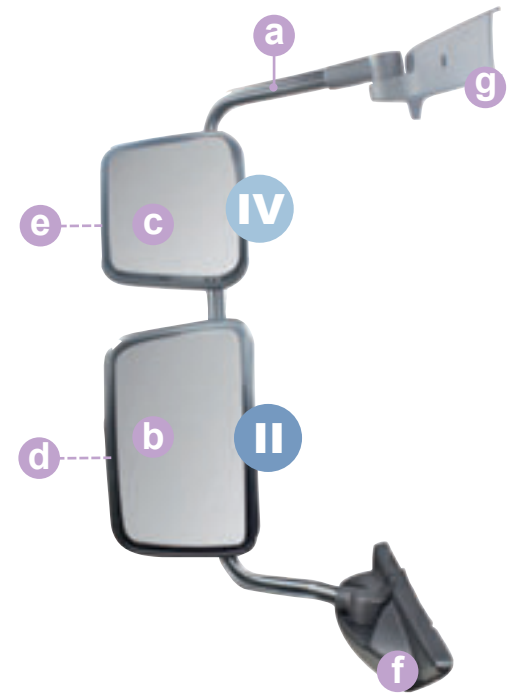

LF0/513

II

-



241x370 mm

LF0/511

IV

-



234x245 mm

LF0/503



S
M
L

a LF0/509

20903723



+ **g**
387x895 mm

b PRM/504

20862795

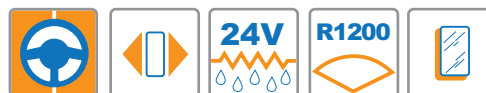

E4 024104
202x337 mm

c LF0/505

20862810



E4 024105
200x197 mm

d LF0/506

20862779



241x369 mm

e LF0/507

20862800



235x241 mm

f PRM/513

20708110



g PRM/523

-



COVIND

VOLVO

suitable to VOLVO

3FH/504

22286155



II

E4 024111

200x435 mm



IV

E4 0244639

200x185 mm

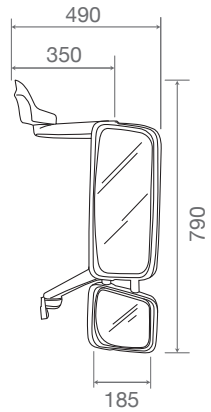

applicabilità:
applicable to:
Verwendbar für

VOLVO 3FH. FH III
VOLVO 3FM. FM III



-

II

3FH/506

IV



240x235 mm

3FH/504



S
M
L

a

- -

b

2FH/503

21320404
(20589788)

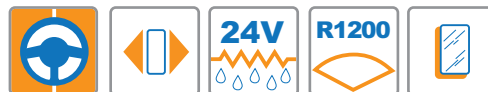

E4 024111
200x435 mm

II

c

3FH/509

21320365
(21070768)
(20589798)



E4 0244639
200x185 mm

IV

d

3FH/511

21169974
(20746402)



187x435 mm

II

e

3FH/508

20841436



240x210 mm

IV

suitable to **VOLVO**

3FH/505

22286149



II

E4 024111

200x435 mm



IV

E4 0244639

176x188 mm

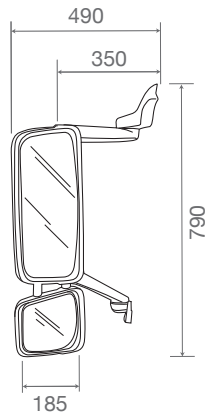

applicabilità:
applicable to:
Verwendbar für

VOLVO 3FH. FH III
VOLVO 3FM. FM III



II

3FH/507

IV



240x235 mm

3FH/505



S
M
L

a

- -

b

2FH/503

21320404
(20589788)

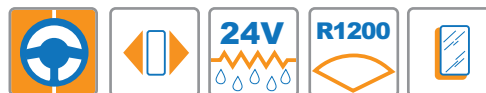

E4 024111
200x435 mm

II

c

3FH/509

21320365
(21070768)
(20589798)

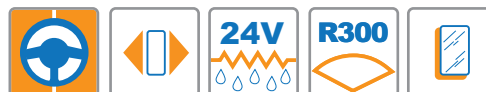

E4 0244639
185x200 mm

IV

d

3FH/511

21169974
(20746402)



187x435 mm

II

e

3FH/508

20841436



240x210 mm

IV

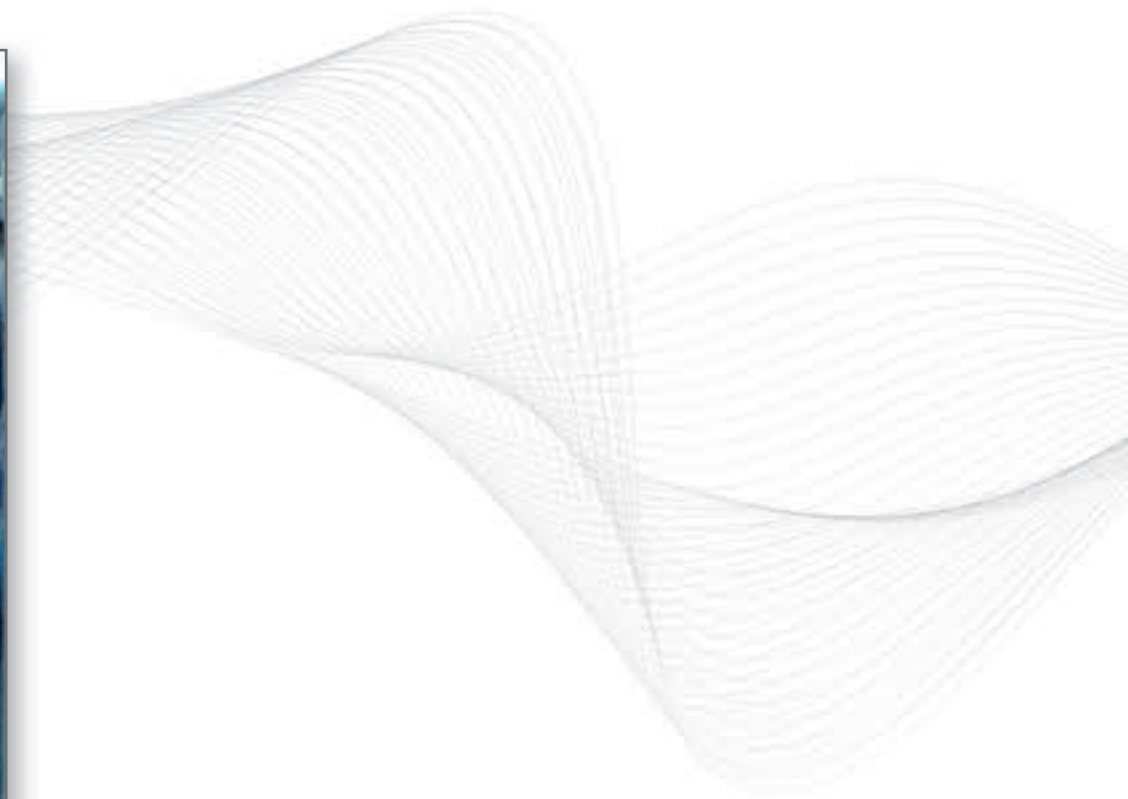
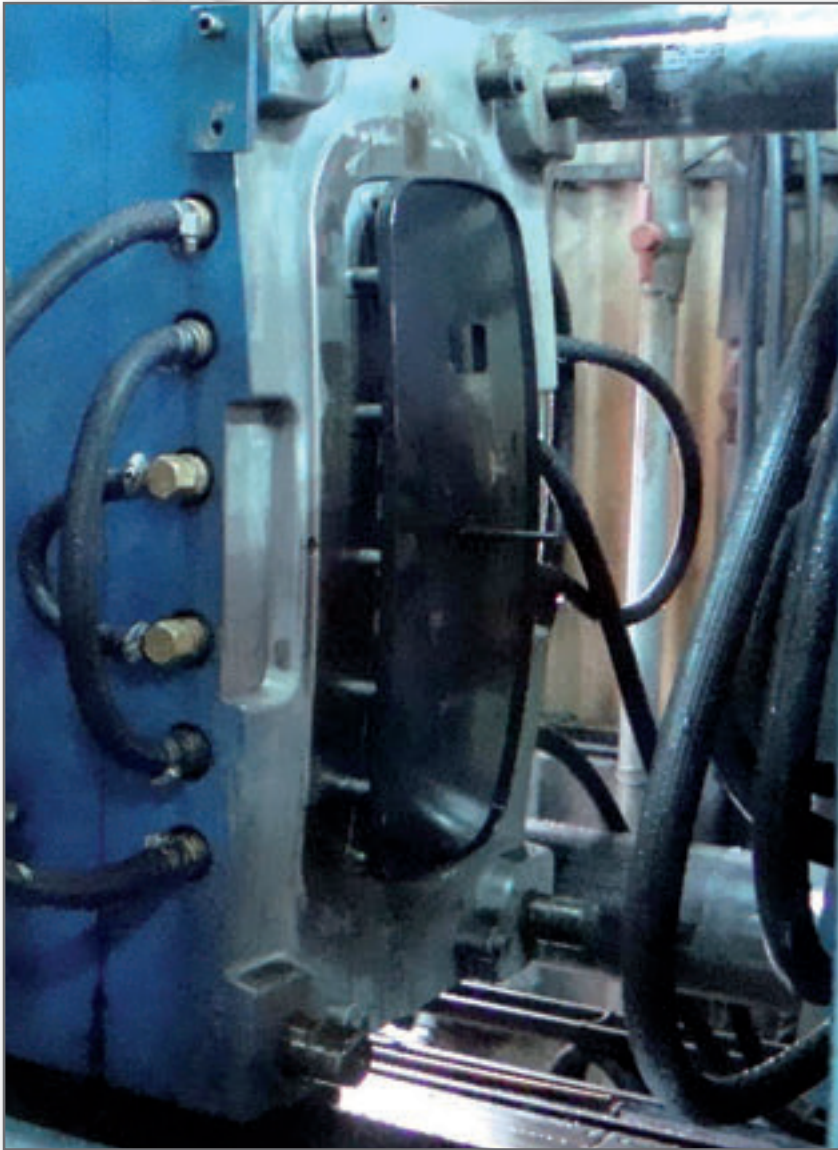



IT Progetto specchi retrovisori. Stampo supporto specchio principale (II) in ABS
EN Rear - view mirrors project. Mould for ABS glass housing
DE Rückspiegel-Projekt. Stahlform für ABS Hauptspiegelhalter (II)

COVIND SPA

SERVIZIO VENDITE ITALIA DOMESTIC SALES DPT.

 +39 011 8965702

 +39 011 8965714

 +39 011 8965719

 +39 011 8965756

E.MAIL vendite@covind.it

SERVIZIO VENDITE ESTERO INTERNATIONAL SALES DPT.

 +39 011 8965722

 +39 011 8965735

 +39 011 8965759

 +39 011 8005149

E.MAIL export@covind.it



COVIND S.P.A.

Strada della Cebrosa, 68-70-72

10036 Settimo Torinese (TO) - ITALY

☎ +39 011 8965711

☎ +39 011 8977830

marketing@covind.it

www.covind.it

